

Sitaleicht. Product overview.

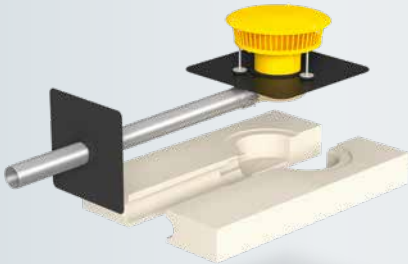

leicht entwässern.

Sitaleicht.
When it's made
really easy
to find the
best product.

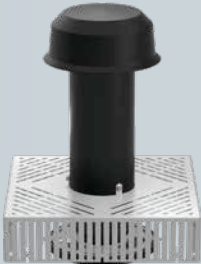
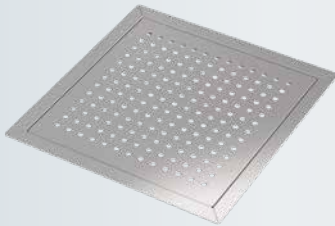
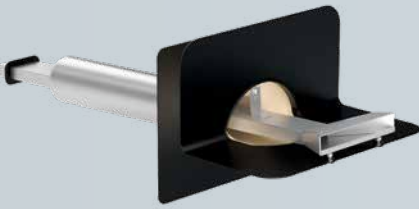

1

Products

04 The Sita range at a glance

06 Conventional drainage

07 Product details
 11 Possible combinations



12 Siphonic drainage

13 Product details
 17 Possible combinations



18 Emergency drainage

19 Product details
 29 Possible combinations



30 Parapet drainage

31 Product details
 37 Possible combinations



38 Cascade drainage

39 Product details
 43 SitaKaskade. The practical component system.

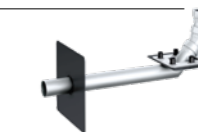

44 Balcony and terrace drainage

45 Product details
 53 Possible combinations



54 Drainage

55 Product details
 67 Possible combinations



68 Green roof and Retention

69 Product details
 73 Possible combinations

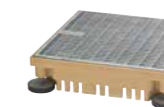

74 Refurbishment

75 Product details
 79 Possible combinations



80 Ventilation and pipe fairlead

81 Product details
 85 Possible combinations



86 Fire protection

87 Product details
 97 Possible combinations

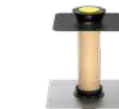

98 SitaPipe

99 Product details SitaPipe stainless steel
 100 Possible combinations
 101 Product details SitaPipe PP
 102 Possible combinations



104 Connecting sleeves
 106 Sita's excellent performance
 107 Sita calculation service

2

Sitaleicht

110 Sita contacts

Superbly served - with the Sita product range.

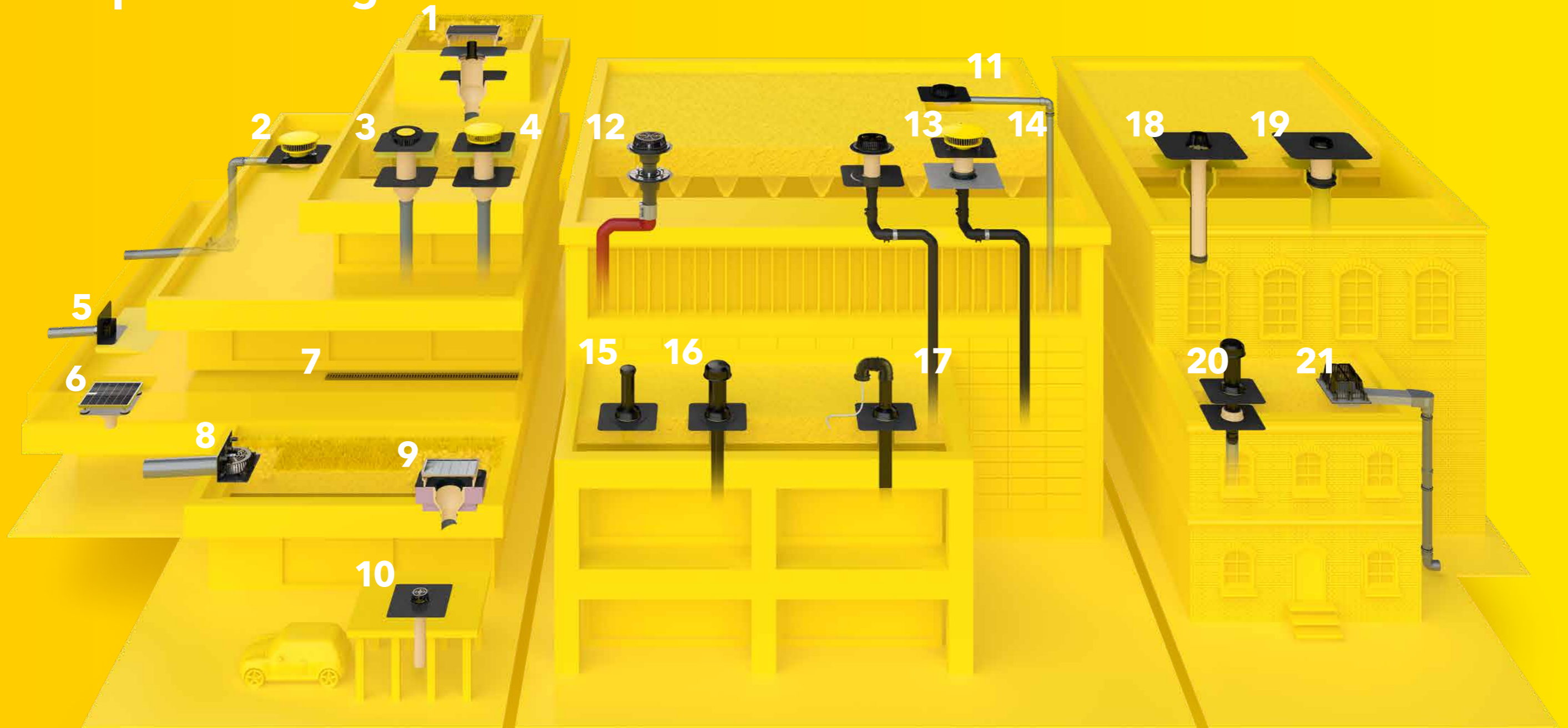

- 1** SitaRetention green roof shaft with SitaRetention Fix
- 2** SitaKaskade Inside with SitaDSS Indra emergency drainage set and SitaPipe stainless steel pipe system
- 3** SitaStandard with SitaStandard extension unit and insulating body in use for the extension unit
- 4** SitaStandard with SitaStandard extension unit and SitaMore retaining element

- 5** SitaEasy
- 6** SitaDrain® Terra with SitaCompact
- 7** SitaDrain® box drain with footbridge
- 8** SitaRondo
- 9** SitaGreen roof shaft with SitaTrendy and SitaTrendy insulating body
- 10** SitaCarport

- 11** SitaDSS Indra main drainage set
- 12** SitaDSS Multi with SitaDSS Multi extension unit
- 13** SitaDSS Profi with SitaDSS Profi extension unit
- 14** SitaDSS Fireguard®
- 15** SitaVent Revision

- 16** SitaVent system vent with SitaVent condensation deflector
- 17** SitaVent pipe bent with pipe fairlead
- 18** SitaSani® drainage into the existing pipe system
- 19** SitaSani® drainage into the existing roof outlet
- 20** SitaVent refurbishment vent
- 21** SitaTurbo loose retention valve

CD

for Conventional Drainage:

Your roof needs drainage!

Rainwater weighs heavy on roofs – and can be a real test for the seal and structural strength. Conventional drainage is the most common type of roof drainage for flat roofs. It is governed by clear design regulations. The required number of rainwater outlets is defined by the size of the roof area. A separate fall pipe is generally connected to each rainwater outlet – so that rainfall can be drained reliably at all times.

SitaStandard



Properties

The classic Sita item is ideal for almost any installation situation: the SitaStandard. Thanks to the thermally insulated rainwater outlet body made from rigid polyurethane integral foam, it can withstand compressive forces and is also resistant to normal environmental effects. The SitaStandard features a large inlet part and a high discharge volume resulting out of that.

- + Maximum discharge volume
- + Up to size DN 200
- + Robust construction
- + Homogeneous roofing membrane connection
- + Suitable for bridging all insulation thicknesses from 60 to 520 mm

Installation example

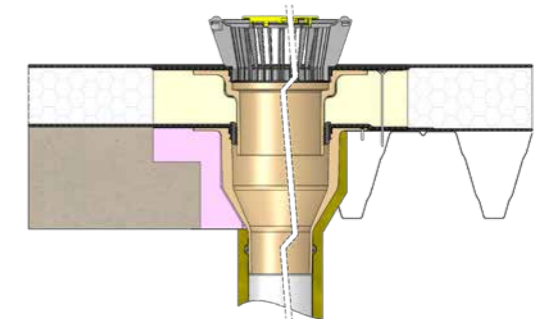



Accessories



Quality marks



SitaStandard	DN	OD*	Article number
	70	75	10 02 xx
	100	110	10 04 xx
	125	125	10 06 xx
	150	160	10 08 xx
	200	200	10 10 xx
	70/100	75/110	10 30 xx
	70	75	10 14 xx
	100	110	10 16 xx
	125**	125	10 18 xx

SitaStandard	Insulation thickness (mm)	Article number
	60 - 160	10 25 xx
	60 - 220	10 26 xx
	60 - 520	10 50 xx

*OD = Outer diameter

**With transition from DN 100 to DN 125.

Important! Specify the selected connection sleeve (xx) in your order (see page 104). 07

SitaTrendy



Properties

The SitaTrendy features a compact design and high discharge volume. The flexible rainwater outlet is available with a selected connection sleeve and compatible with the SitaTrendy screw-on flange product family.

- + Compact design
- + Discharge rate considerably above the requirements of DIN EN 1253-2
- + Also available with foamed-in heating element
- + With foamed-in connection sleeve of choice, screw-on flange or adhesive flange

Installation example

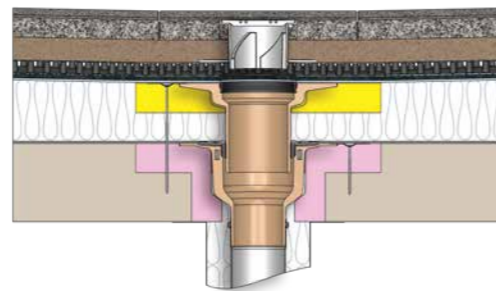

Accessories

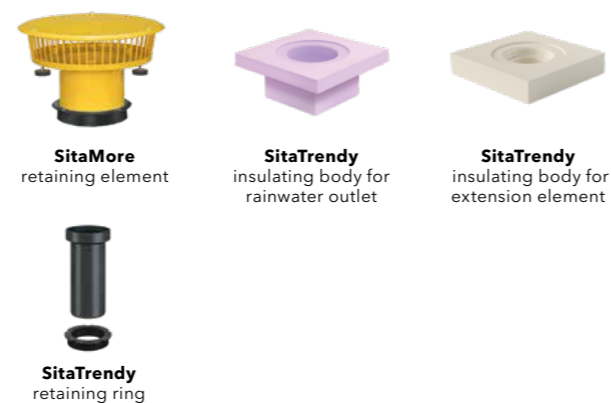

Quality marks



SitaTrendy	Insulation thickness (mm)	Article number
	60-150	15 25 xx
	60-220	15 26 xx
	60-320	15 27 xx

SitaTrendy	DN	OD*	Article number
	70	75	15 02 xx
	90	90	15 01 xx
	100	110	15 04 xx
	125	125	15 06 xx
	70	75	15 14 xx
	100	110	15 16 xx
	125**	125	15 18 xx

08 *OD = Outer diameter
**With transition from DN 100 to DN 125.

Important! Specify the selected connection sleeve (xx) in your order (see page 104).

SitaTrendy screw-on flange



Properties

The SitaTrendy screw-on flange features a compact design and high discharge volume. The flexible rainwater outlet is also compatible with the SitaTrendy product family.

- + Compact design
- + Discharge capacity significantly higher than the requirements of DIN EN 1253-2
- + Also available with foamed in heating element
- + Compatible with SitaTrendy

Installation example

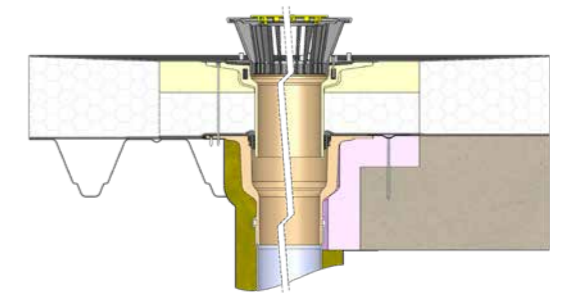

Accessories



Quality marks



SitaTrendy screw-on flange	DN	OD*	Article number
	70	75	15 02 99
	90	90	15 01 99
	100	110	15 04 99
	125	125	15 06 99
	70	75	15 14 99
	100	110	15 16 99
	125**	125	15 18 99

SitaTrendy screw-on flange	Insulation thickness (mm)	Article number
	60-150	15 25 99
	60-220	15 26 99
	60-320	15 27 99

*OD = Outer diameter
**With transition from DN 100 to DN 125.

This is how easy combinations are generated.

Sitaleicht.
Conventional
Drainage.



Accessories	Product series							
	SitaStandard vertical	SitaStandard stepped outlet	SitaStandard angled	SitaTrendy vertical	SitaTrendy angled	SitaTrendy screw-on flange vertical	SitaTrendy screw-on flange angled	
SitaMore safety heating system								
SitaMore reinforcement plate for steel trapezoidal plate roofs								
SitaMore dome grate Allround								
SitaMore Terrace Kit								
SitaMore vapour barrier plate								
SitaAttika cladding cover plate								
SitaMore sealing sleeve								

The SitaMulti can be found under the fire protection section of this catalogue

Sitaleicht. Check it out online now: sita-bauelemente.de/gb/

SD

for Siphonic Drainage:

Drainage at full capacity!

Do you have particularly large roof areas on industrial, free-standing buildings? And you have a need for great space inside them? In that case siphonic drainage is the ideal system for you. Fewer ground pipelines are required for it – which means that almost no earthworks are needed. The drainage takes place internally in full, minimising the number of fall pipes – this saving space overall.

SitaDSS Profi



SitaDSS Profi



SitaDSS Profi without Airstop





SitaDSS Profi extension unit

Properties

This series was developed by specialists for specialists. In addition to a high discharge volume, the SitaDSS Profi series features particularly low pressure losses and is simple to install. Only a few components and actions are required on site to assemble a perfect siphonic drainage system. The siphonic drainage rainwater outlet is available with a selected connection sleeve.

- + For direct connection to PE pipelines
- + High discharge volume
- + Easy installation due to small number of parts
- + Suitable for universal use
- + With selected connection sleeve

SitaDSS Profi	DN	OD*	Article number
 vertical	56	56	14 02 xx
	70	75	14 04 xx
 without Airstop	56	56	14 32 xx**
	70	75	14 34 xx**

SitaDSS Profi	Insulation thickness (mm)	Article number
 extension unit	60-150	14 25 xx
	60-220	14 26 xx
	60-320	14 27 xx

*OD = Outer diameter
**To be utilised in combination with the SitaDSS Profi retaining element only.

Installation example

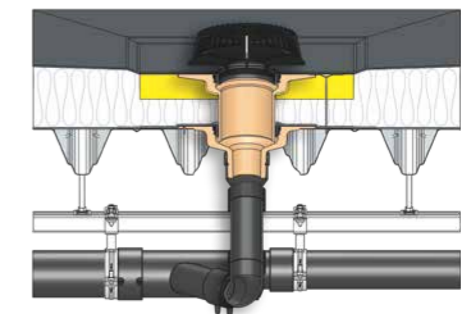

Accessories



SitaDSS Profi retaining element



SitaDSS Profi insulating body for extension element



SitaMore transition connector set

Quality marks



Important! Specify the selected connection sleeve (xx) in your order (see page 104). 13

SitaDSS Profi screw-on flange

SD

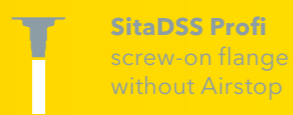

Properties

This series was developed by specialists for specialists. In addition to a high discharge volume, the SitaDSS Profi screw-on flange series features particularly low pressure losses and is simple to install. Only a few components and actions are required on site to assemble a perfect siphonic drainage system. The siphonic drainage rainwater outlet is available with the approved flexible loose-fixed flange connection.

- + For direct connection to PE pipelines
- + High discharge volume
- + Easy installation due to small number of parts
- + Suitable for universal use
- + With screw-on flange

Installation example

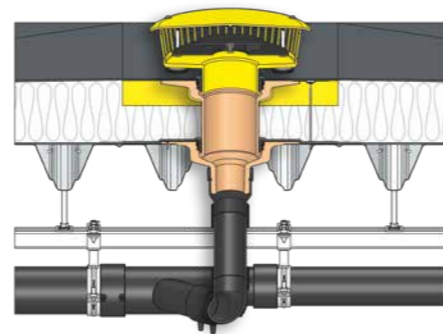

Accessories



SitaDSS Profi
retaining element

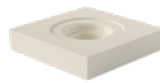

SitaDSS Profi
insulating body for
extension element



SitaMore
transition connector set

Quality marks



SitaDSS Profi	Insulation thickness (mm)	Article number
extension unit	60-150	14 25 99
	60-220	14 26 99
	60-320	14 27 99

SitaDSS Ravana

SD



Properties

The SitaDSS Ravana gutter rainwater outlet certified to EN 1253-2:2013 will also fit into 200 mm narrow gutters without modification, thus delivering maximum flexibility in application and installation. Round off your product range and scope of services with the new SitaDSS Ravana. Make work easy for yourself and benefit from greater planning security.

- + For narrow roof areas or gutters
- + For main and emergency drainage
- + Width just 195 mm
- + Non-flammable

Installation example

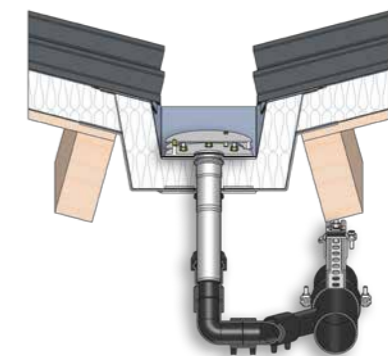

SitaDSS Ravana	DN	OD*	Article number
vertical	50	50	28 00 99

SitaDSS Ravana	Insulation thickness (mm)	Article number
extension unit	50-160	28 25 99

SitaDSS Ravana	Damming height from-to (mm)	Article number
retaining element	30-150	28 90 01

Quality marks



SitaDSS Ravana Plus

SD



SitaDSS Ravana Plus
for liquid applied waterproofing

Properties

The SitaDSS Ravana Plus gutter rainwater outlet developed for liquid applied waterproofing will fit into 200 mm narrow gutters without modification. That means maximum flexibility in application and installation.

- + For narrow gutters
- + For sealing with liquid compounds
- + Adhesive flange can be adjusted to the gutter geometry
- + With prefabricated holes for fastening direct to the substructure

Installation example

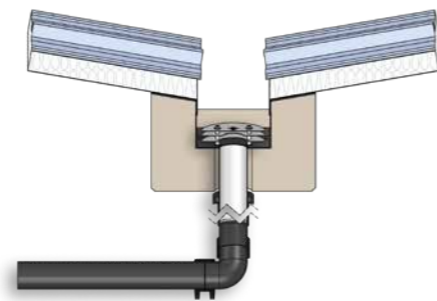



















Quality marks

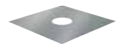

SitaDSS Ravana Plus	DN	OD*	Article number
 for liquid applied waterproofing	70	75	28 10 99

This is how easy combinations are generated.

SD

Accessories	Product series					
	SitaDSS Profi	SitaDSS Profi without Airstop	SitaDSS Profi screw-on flange	SitaDSS Profi screw-on flange without Airstop	SitaDSS Ravana	SitaDSS Ravana Plus
						
SitaMore safety heating system 						
SitaMore reinforcement plate for steel trapezoidal plate roofs 						

+ You will find the SitaMulti in the category fire protection

ED

for Emergency Drainage:

You must get the water off the roof.

You need an emergency drainage system to get the water off your roof if it rains heavily. The main drainage system cannot manage these large volumes quickly enough. As climate change takes hold, an increase in heavy rainfall incidents is predicted. Rain can be a burden. To protect people, buildings and property, there are binding regulations which treat rain drainage systems as a whole.

SitaTurbo

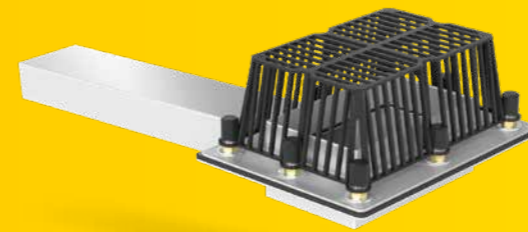

 SitaTurbo with loose retaining flange

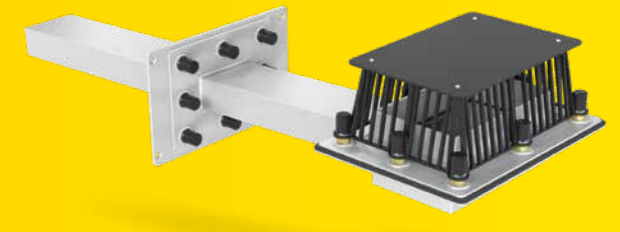

 SitaTurbo inverted roof

Properties SitaTurbo with loose retaining flange

The SitaTurbo with loose retaining flange is something really special. When installed in the roof structure, this robust and extremely flat rainwater outlet routes water outwards through the parapet. The slight weakening of the thermal insulation and the external pipeline system minimise thermal bridges.

- + Very high discharge rate
- + For main and emergency drainage
- + Extremely flat construction
- + Screw-on flange construction

Properties SitaTurbo inverted roof

The SitaTurbo inverted roof has been specially developed for the emergency drainage of inverted roofs. The sealing membrane has a watertight connection to the loose-fixed flange construction on the rectangular pipe. The water-draining fleece is clamped in the loose-fixed flange connection of the inlet pot and minimises water ingress into the installation level.

- + Very high discharge rate
- + For the emergency drainage of inverted roofs
- + Matching XPS insulating bodies available
- + Screw-on flange construction

SitaTurbo with loose retaining flange	Pipe 600 mm*	Article number
	25 mm retention	18 63 99
	35 mm retention	18 65 99
	45 mm retention	18 67 99
	55 mm retention	18 69 99
	Pipe 1000 mm*	Article number
	25 mm retention	18 64 99
	35 mm retention	18 66 99
	45 mm retention	18 68 99
	55 mm retention	18 70 99
	Pipe 2000 mm*	Article number
	25 mm retention	18 72 99
	35 mm retention	18 73 99
45 mm retention	18 76 99	
55 mm retention	18 77 99	

SitaTurbo inverted roof	Pipe length	Article number
	To order	18 59 99

Quality marks



*Other pipe lengths are possible upon request.

SitaTurbo Max

SitaTurbo Max with retaining ring

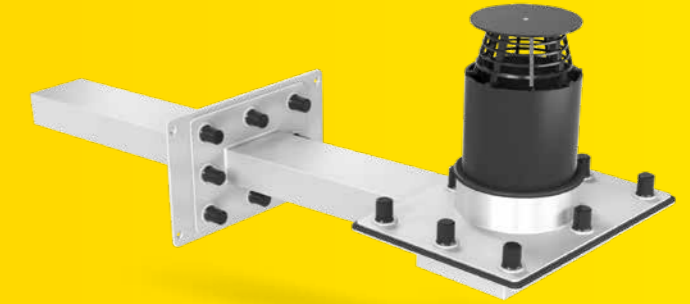
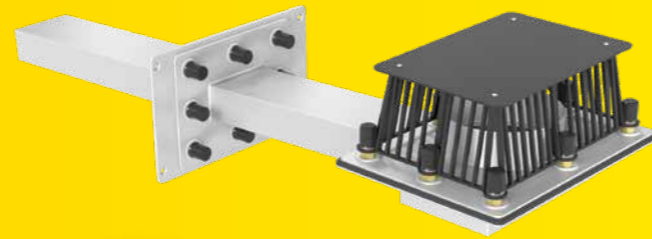
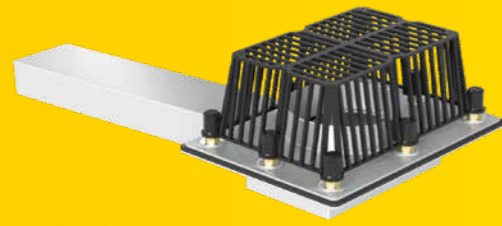

 SitaTurbo Max with loose retaining flange

 SitaTurbo Max inverted roof

 SitaTurbo Max with retaining ring

 SitaTurbo Max inverted roof with retaining ring

Properties SitaTurbo Max with loose retaining flange

The SitaTurbo is something really special. When installed in the roof surface, this robust and extremely flat roof outlet routes water outwards through the parapet. Minimal weakening of the thermal insulation and the external pipeline system minimise thermal bridges. The standard Turbo is great for piped drainage, but the SitaTurbo Max has a round inlet to optimise flow characteristics, making it perfect for use with a spout.

- + Up to 65% larger discharge rate than the SitaTurbo
- + For main and emergency drainage
- + Extremely flat construction
- + Screw-on flange construction

Properties SitaTurbo Max inverted roof

The SitaTurbo Max inverted roof has been specially developed for the emergency drainage of inverted roofs. The sealing membrane has a watertight connection to the screw-on flange construction on the rectangular pipe. The water-draining fleece is clamped in the screw-on flange connection of the inlet pot and minimises water ingress into the installation level.

- + Up to 65% larger discharge rate than the SitaTurbo
- + For emergency drainage on inverted roofs
- + Matching XPS insulating bodies available
- + Screw-on flange construction

Properties SitaTurbo Max with retaining ring

The SitaTurbo is something really special. When installed in the roof surface, this robust and extremely flat roof outlet routes water outwards through the parapet. Minimal weakening of the thermal insulation and the external pipeline system minimise thermal bridges. The standard Turbo is great for piped drainage, but the SitaTurbo Max has a round inlet to optimise flow characteristics, making it perfect for use with a spout.

- + Up to 65% larger discharge rate than the SitaTurbo
- + For main and emergency drainage
- + Extremely flat construction
- + Screw-on flange construction

Properties SitaTurbo Max inverted roof with retaining ring

The SitaTurbo Max inverted roof with retaining ring has been specially developed for the emergency drainage of inverted green roofs. The sealing membrane has a watertight connection to the screw-on flange construction on the rectangular pipe. The water-draining fleece is clamped in the screw-on flange connection of the inlet pot and minimises water ingress into the installation level. The retaining ring can be flexibly shortened on site.

- + Up to 65% larger discharge rate than the SitaTurbo
- + For emergency drainage on inverted roofs
- + Matching XPS insulating bodies available
- + Screw-on flange construction

SitaTurbo Max with loose retaining flange	Pipe 600 mm*	Article number
	10 mm retention	18 06 10 99
	25 mm retention	18 06 25 99
	35 mm retention	18 06 35 99
	45 mm retention	18 06 45 99
	55 mm retention	18 06 55 99
	Pipe 1000 mm*	Article number
	10 mm retention	18 10 10 99
	25 mm retention	18 10 25 99
	35 mm retention	18 10 35 99
	45 mm retention	18 10 45 99
	55 mm retention	18 10 55 99
	Pipe 2000 mm*	Article number
	10 mm retention	18 20 10 99
	25 mm retention	18 20 25 99
	35 mm retention	18 20 35 99
	45 mm retention	18 20 45 99
	55 mm retention	18 20 55 99

SitaTurbo Max inverted roof	Pipe length	Article number
	To order	18 21 00 99

SitaTurbo Max with retaining ring	Pipe 600 mm*	Article number
	200 mm retention	18 06 65 99
	Pipe 1000 mm*	Article number
	200 mm retention	18 10 65 99
	Pipe 2000 mm*	Article number
	200 mm retention	18 20 65 99

SitaTurbo Max inverted roof with retaining ring	Pipe length	Article number
	To order	18 21 65 99

Quality marks



Quality marks



SitaRondo



 **SitaRondo**
loose retaining flange

 **SitaMore**
vapour barrier plate

Properties

The SitaRondo with round pipe is suitable for main and emergency drainage through the parapet where internal downspouts cannot be used for drainage. The screw-on -fixed flange construction of the SitaRondo guarantees flexible connection options for all standard roof membranes.

- + For main and emergency drainage
- + Special lengths possible
- + Material: rust-proof stainless steel
- + Direct connection to the SitaPipe stainless steel pipe system possible
- + Single-part loose flange loose retaining flange

Installation example

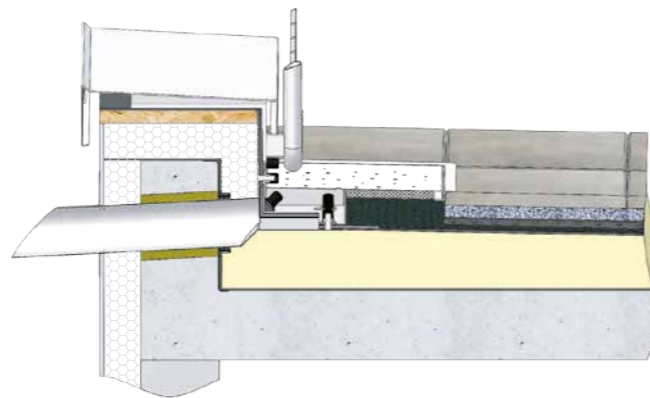

SitaRondo	DN	OD*	Loose flange height (mm)	Article number
	50	50	35	18 20 11 99
	50	50	55	18 20 20 99
	50	50	100	18 20 30 99
	70	75	35	18 22 10 99
	70	75	55	18 22 20 99
	70	75	100	18 22 30 99
	100	110	35	18 24 10 99
	100	110	55	18 24 20 99
	100	110	100	18 24 30 99
	125	125	35	18 26 10 99
	125	125	55	18 26 20 99
	125	125	100	18 26 30 99

SitaSpy

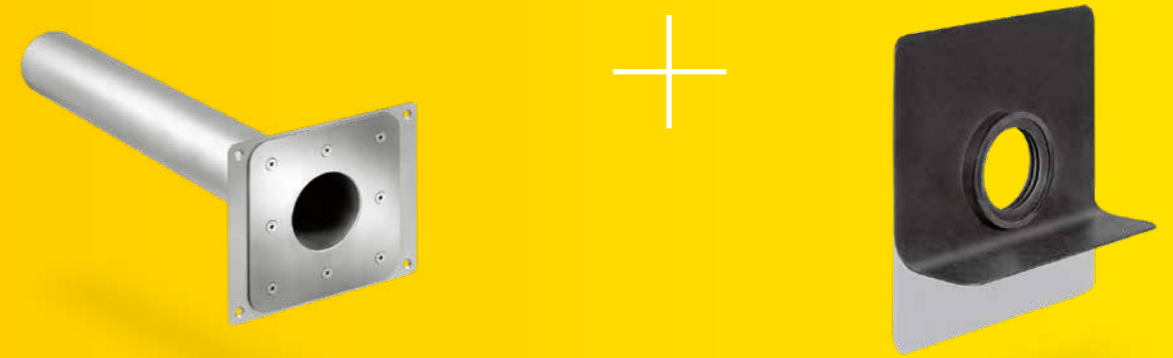

 **SitaSpy**

 **SitaMore**
vapour barrier plate

Properties

For emergency drainage of small roof areas according to DIN 1986-100, such as balconies, loggias and terraces. SitaSpy is characterised by a visually attractive screw-on flange construction, without protruding screws or threaded rods.

- + Visually attractive through countersunk screw connections
- + Screw-on flange construction
- + With a pipe length of 800 mm
- + Inclination 3°

Installation example

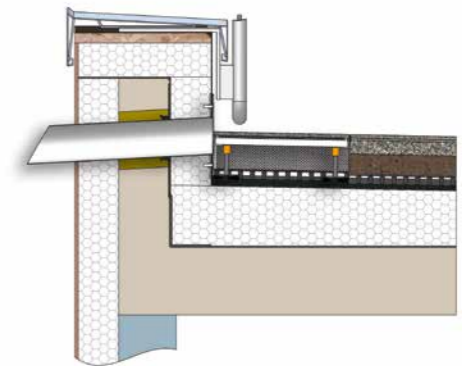

SitaSpy	DN	OD*	Article number
	50	50	18 41 99
	70	75	18 42 99
	100	110	18 44 99

SitaIndra / SitaDSS Indra

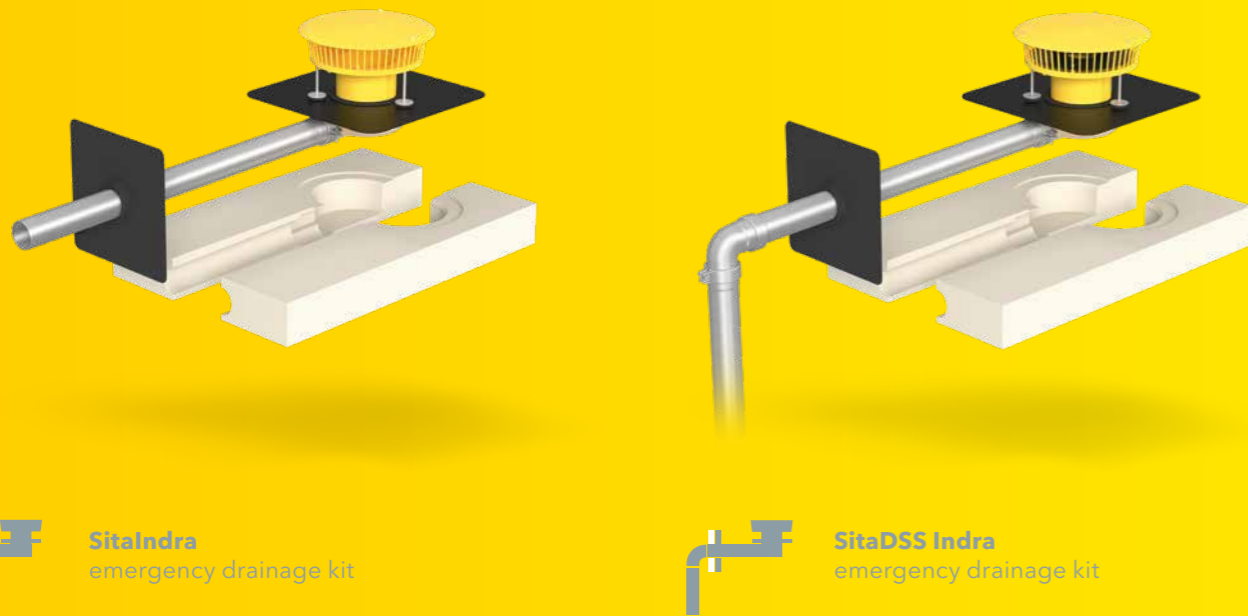

 **SitaIndra**
emergency drainage kit

 **SitaDSS Indra**
emergency drainage kit

Properties

Very light, very flat and very quick to install! With these benefits, the SitaIndra and SitaDSS Indra can convince installers who want effective thermal insulation. The parapet drainage rainwater outlet made from thermally insulated PUR is supplied as a complete set including insulating bodies.

SitaIndra emergency drainage set

- + Available as a complete set: No additional purchase required
- + Very low installation height: Less weakening of the thermal insulation
- + Can be connected to SitaPipe stainless steel pipe system
- + Inclination gradient 1°

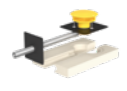
SitaIndra	DN	OD*	Set variants	Article number
	70	75	with polyurethane insulating body	10 74 xx
	70	75	with mineral wool insulating body	10 84 xx

Quality marks



SitaDSS Indra emergency drainage set

- + The siphonic drainage system for small and large areas
- + Easy installation with a complete set
- + Available with three alternative fall pipe lengths
- + Can be connected to SitaPipe stainless steel pipe system

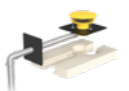
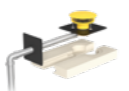
SitaDSS Indra	DN	OD*	Set variants with polyurethane insulating body	Article number
	70	75	Set 4: 2.0 m fall pipe	14 74 xx
	70	75	Set 5: 3.0 m fall pipe	14 76 xx
	70	75	Set 6: 4.0 m fall pipe	14 78 xx
	DN	OD*	Set variants with mineral wool insulating body	Article number
	70	75	Set 10: 2.0 m fall pipe	14 84 xx
	70	75	Set 11: 3.0 m fall pipe	14 86 xx
	70	75	Set 12: 4.0 m fall pipe	14 88 xx

SitaVasant Double



 **SitaVasant Double**

Properties

A gully with two separate inlets that function independently of each other, that is what is special about the SitaVasant Double. Main drainage and emergency drainage are combined in one gully and require only one penetration in the parapet. If the water level on the roof rises to the emergency drainage level, an emergency drainage channel offset in height by 35 mm is provided, which discharges onto a freely floodable surface.

- + For main drainage or combined main/emergency drainage
- + As a set for easy installation
- + In combination with a transition piece for connection to the downpipe
- + With connection sleeve of choice**

SitaVasant Double	DN	OD*	Article number
	100	110	50 05 xx**

Installation example

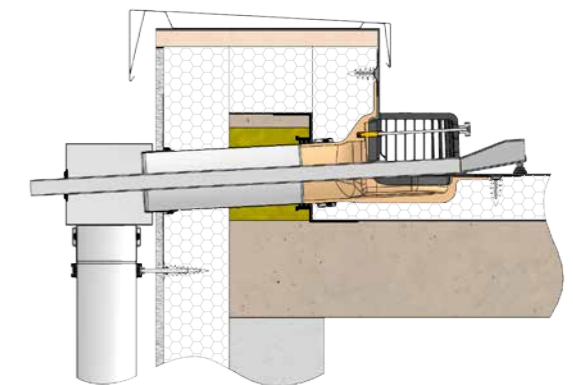

Accessories



SitaVasant Double
adapter



SitaVasant Double
grating

Quality marks



SitaEasy / SitaEasy Plus / SitaEasy Go



Properties

The SitaEasy is suitable for main and emergency drainage through the parapet. The foamed in selected connection sleeve provides installers with a simple, safe and homogeneous connection to the roof seal.

The SitaEasy Plus is a small parapet drainage rainwater outlet specially developed for emergency drainage. Its integrated selected connection sleeve enables installers to achieve a simple, secure and homogeneous connection with the roofing membrane on the parapet.

The SitaEasy Go is the perfect parapet solution for bitumen-sealed roof areas such as balconies and terraces. With its 45° wedge design, it fits perfectly with the thermal insulation, ensuring that bitumen roof membranes can be welded straight to it.

- + For main and emergency drainage
- + With integrated selected connection sleeve
- + With angled or straight fixed flange
- + Can be combined with the stainless steel SitaPipe stainless steel pipe system
- + Can be combined with vapour barrier plate flex

Accessories



SitaEasy retaining element



SitaEasy dome grate



SitaEasy Go dome grate

Installation example

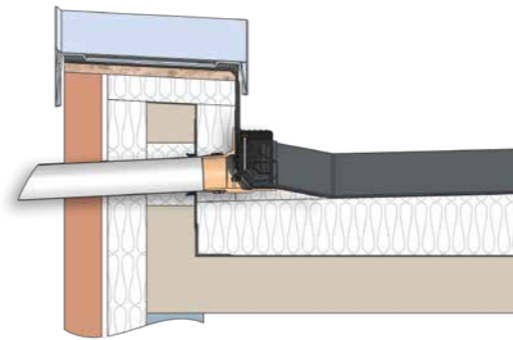

SitaEasy	DN	OD*	Article number
	50	50	18 30 xx
	70	75	18 32 xx
	100	110	18 34 xx

SitaEasy Plus	DN	OD*	Article number
	70	75	18 02 xx**
	100	110	18 04 xx
	125	125	18 06 xx
	150	160	18 08 xx

SitaEasy Go	DN	OD*	Article number
	70	75	18 36 00
	100	110	18 38 00

*OD = Outer diameter

** Apart from end number 03 (Firestone Quickseam SA Flashing) and 84 (Novoproof with join-in technology).

Important! Specify the selected connection sleeve (xx) in your order (see page 104)..

SitaDSS and SitaMore Retaining element

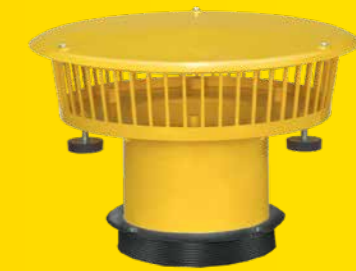
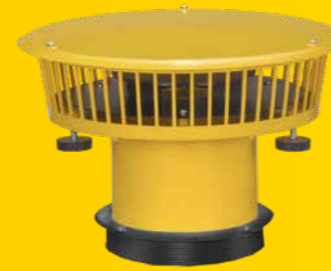

Properties

The SitaDSS and SitaMore retaining elements in signal yellow combine a wide range of benefits. Together with the Sita rainwater outlets, the retaining element functions as a high performance emergency drainage unit used both for conventional and siphonic drainage.

- + For combination with Sita rainwater outlets
- + For conventional and siphonic drainage
- + For effective emergency drainage
- + Infinitely height adjustable
- + With screw-on sealed cover

Installation example

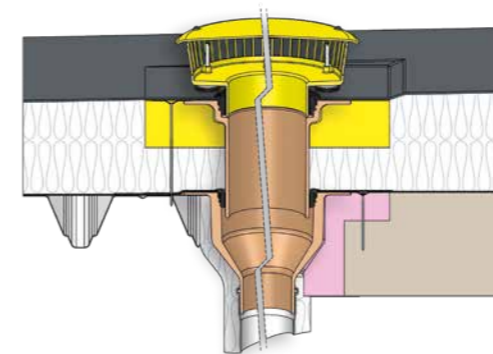

SitaDSS retaining element	For series	Height of the inlet edge from-to (mm)	Article number
	SitaDSS Profi	25 - 105	14 90 01
		85 - 150	14 90 11
		135 - 200	14 90 12
	SitaDSS Multi	25 - 105	12 90 01
		85 - 150	12 90 11
		135 - 200	12 90 12
	SitaDSS Indra retaining element	85 - 150	14 90 76
		135 - 200	14 90 77

SitaMore retaining element	For series	Height of the inlet edge from-to (mm)	Article number
	SitaStandard / SitaMulti	25 - 105	10 90 01
		85 - 150	10 90 07
		135 - 200	10 90 08
	SitaTrendy / SitaSani®	25 - 105	15 90 01
		85 - 150	15 90 07
		135 - 200	15 90 08
	SitaIndra retaining element	85 - 150	10 90 76
		135 - 200	10 90 77











Quality marks



Sitaleicht. Emergency Drainage.



This is how easy combinations are generated.

Accessories	Product series									
	SitaTurbo/ SitaTurbo Max	SitaTurbo / SitaTurbo Max inverted roof	SitaRondo with loose retaining flange	SitaSpy	SitaIndra	SitaDSS Indra	SitaVasant Double	SitaEasy / SitaEasy Go	SitaEasy Plus	SitaDSS/ SitaMore retaining element
 SitaAttika cladding cover plate	○	○	○	○	○	○	○	○	○	
 SitaTurbo vapour barrier plate flex	○									
 SitaMore vapour barrier plate flex			○	○				○	○	
 SitaMore vapour barrier plate Duoflex			○		○	○		○		
 SitaMore retaining ring					○					
 SitaMore PE-connection pipe								○	○	
 SitaStandard										○
 SitaTrendy										○
 SitaMulti										○
 SitaDSS Profi										○
 SitaDSS Multi										○

Sitaleicht. Check it out online now: sita-baelemente.de/gb/

PPD

for Parapet Drainage:

Keep the water off!

Parapet drainage removes the water quickly and directly from the roof – with either a pipe system or using waterspouts. Since the drainage is external, it also means that the water stays off. An ideal solution for buildings where internal drainage is not possible. The installation of the system hardly affects the existing building. Drainage through the parapet is also durable – drain to the outside, rainwater volumes can also be used for other purposes.

SitaTurbo

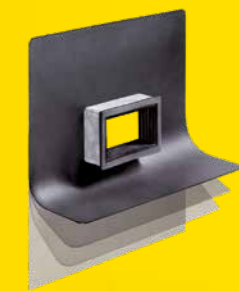
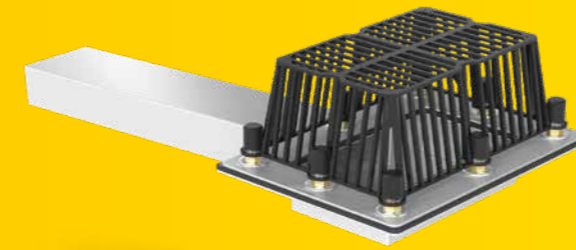

Properties

The SitaTurbo is something really special. When installed in the roof surface, this robust and extremely flat rainwater outlet routes water outwards through the parapet. The slight weakening of the thermal insulation and the external pipeline system minimise thermal bridges.

- + Particularly high discharge volume
- + For main and emergency drainage
- + Extremely flat construction
- + Material: Stainless steel
- + Loose-fixed flange construction

Installation example

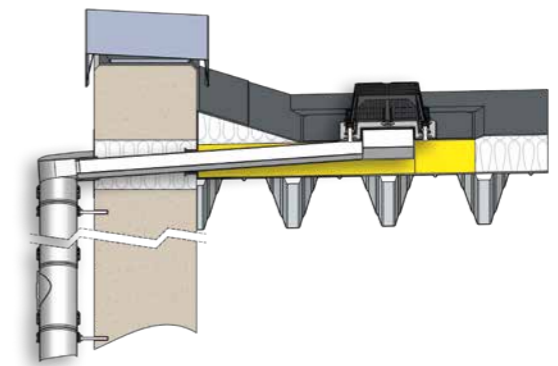

SitaTurbo	Pipe length* (mm)	Article number
	600	18 60 99
	1000	18 62 99
	2000	18 71 99
Cross section of pipe: 120 x 60 mm		

Accessories



SitaTurbo cover plate



SitaTurbo Terrace kit



SitaTurbo connecting sleeve



SitaTurbo adapter

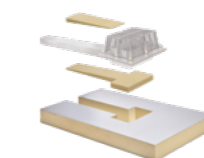

SitaTurbo insulating body

Quality marks



* Other pipe lengths are possible upon request.

SitaRondo

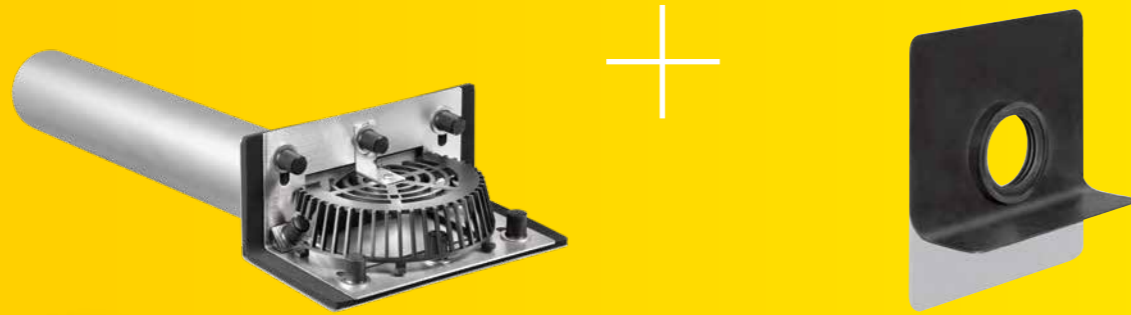



Properties

The SitaRondo with round pipe is suitable for main and emergency drainage through the parapet where an internal fall pipe cannot be used for drainage. The loose-fixed flange construction of the SitaRondo guarantees flexible connection options for all standard roof membranes.

- + For main and emergency drainage
- + Special lengths available
- + Material: Stainless steel
- + Direct connection to the SitaPipe stainless steel pipe system possible
- + One-piece angled loose flange

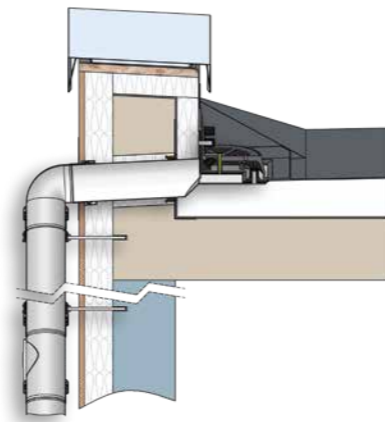
Installation example



SitaRondo	DN	OD*	Article number
	50	50	18 20 99
	70	75	18 22 99
	100	110	18 24 99
	125	125	18 26 99

SitaIndra

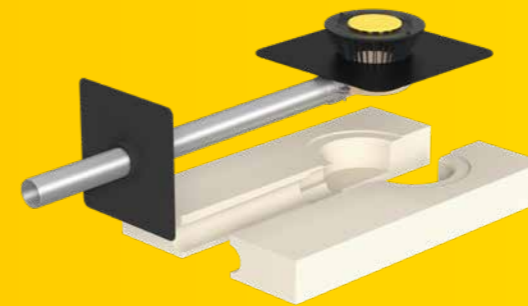

Properties

Very light, very flat and very quick to install! These benefits enable the SitaIndra to persuade installers and everybody who wants effective thermal insulation. The parapet drainage rainwater outlet made from thermally insulated PUR is supplied as a complete set including insulating bodies.

- + Available as a complete set: No additional purchase required
- + Very low installation height: Less weakening of the thermal insulation
- + Can be connected to SitaPipe stainless steel pipe system
- + Inclination gradient 1°

Installation example

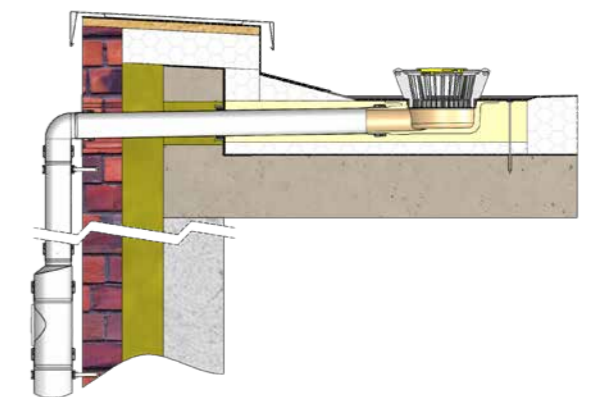

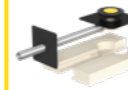
SitaIndra	DN	OD*	Set variants	Article number
	70	75	with polyurethane insulating body	10 73 xx
	70	75	with mineral wool insulating body	10 83 xx

Accessories



SitaMore retaining ring

Quality marks



SitaDSS Indra

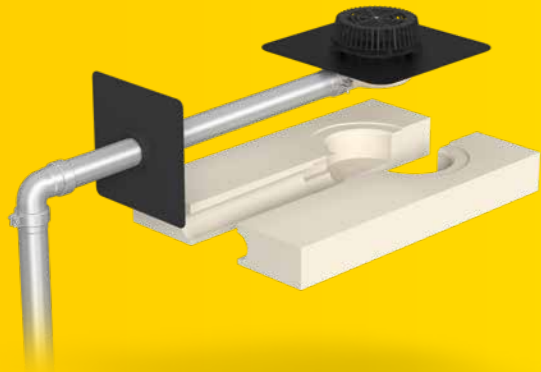

 SitaDSS Indra
main drainage kit

SitaVasant



 SitaVasant

Properties

Discover siphonic drainage through the parapet for small and large roof areas. The SitaDSS Indra is just what you need. The component measures just 98 mm in height, ensuring it fits into the thermal insulation perfectly. Everything you need for quick installation is supplied in a set - all supplied in a yellow Sita box ready to get installed. For either main or emergency drainage. Matching stainless steel pipes included. And everything runs smoothly.

Main drainage

- + Siphonic drainage for small and large areas
- + Easy installation with a complete set
- + Particularly high discharge volume of up to 17.0 l/s
- + Available with three alternative fall pipe lengths
- + Can be combined with the SitaPipe stainless steel pipe system

SitaDSS Indra	DN	OD*	Set variants with polyurethane insulating body	Article number
	70	75	Set 1: 2.0m fall pipe	14 73 xx
	70	75	Set 2: 3.0m fall pipe	14 75 xx
	70	75	Set 3: 4.0m fall pipe	14 77 xx
	DN	OD*	Set variants with mineral wool insulating body	Article number
Main drainage set	70	75	Set 7: 2.0m fall pipe	14 83 xx
	70	75	Set 8: 3.0m fall pipe	14 85 xx
	70	75	Set 9: 4.0m fall pipe	14 87 xx

Quality marks



Properties

Gone are the days when a simple gully was sufficient for drainage at the parapet. Today, drainage capacity is often required there as well. The new SitaVasant delivers it. With its ultra-flat, only 48 mm high it only minimally interferes with the thermal insulation. A pre-mounted inlet pot ensures rapid drainage performance, which accelerates the drainage performance.

- + For main drainage
- + As a set for easy installation
- + In combination with a transition piece for connection to the downpipe
- + With connection sleeve of choice**

SitaVasant	DN	OD*	Article number
	100	110	50 04 xx**

Installation example

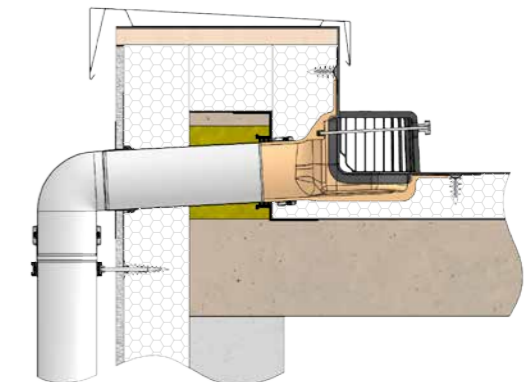

Accessories



SitaVasant
grating

Quality marks



SitaEasy / SitaEasy Go



SitaEasy
 SitaEasy Go
 SitaMore vapour barrier plate

Properties

The SitaEasy is suitable for main and emergency drainage through the parapet. The integrated selected connection sleeve provide installers with a simple, safe and homogeneous connection to the roof seal.

The SitaEasy Go is the perfect parapet solution for bitumen-sealed roof areas such as balconies and terraces. With its 45° wedge design, it fits perfectly against the thermal insulation, ensuring that bitumen roof membranes can be welded straight to it.

- + For main and emergency drainage
- + With integrated selected connection sleeve
- + With angled fixed flange
- + SitaPipe stainless steel pipe can be combined with stainless steel safety clamp
- + Can be combined with vapour barrier plate flex

Installation example

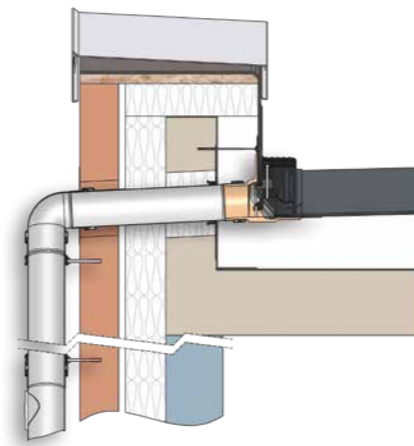

Accessories



SitaEasy dome grate



SitaEasy Go dome grate

SitaEasy	DN	OD*	Article number
	50	50	18 30 xx
	70	75	18 32 xx
	100	110	18 34 xx

SitaEasy Go	DN	OD*	Article number
	70	75	18 36 00
	100	110	18 38 00

This is how easy combinations are generated.

Accessories	Product series					
	SitaTurbo	SitaRondo	SitaIndra	SitaDSS Indra	SitaVasant	SitaEasy/SitaEasy Go
SitaMore PE-connection pipe						
SitaMore vapour barrier plate flex						
SitaMore vapour barrier plate Duoflex						
SitaAttika cladding cover plate						
SitaMore sealing sleeve for WDVS						

K

for Cascade drainage:

Sita cascade drainage is compliant with standards.

It discharges rainfall in a controlled manner in a closed system to the point of transfer to the sewer system or to surfaces that can be flooded without causing damage. Thus, it offers planning certainty and enables uncomplicated installation due to the simple component systems. Concealed pipe installation allows for aesthetic solutions and individual freedom, e.g. in the design of the terrace surface structure.

SitaKaskade Inside

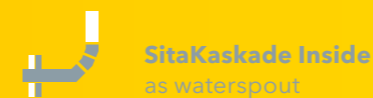
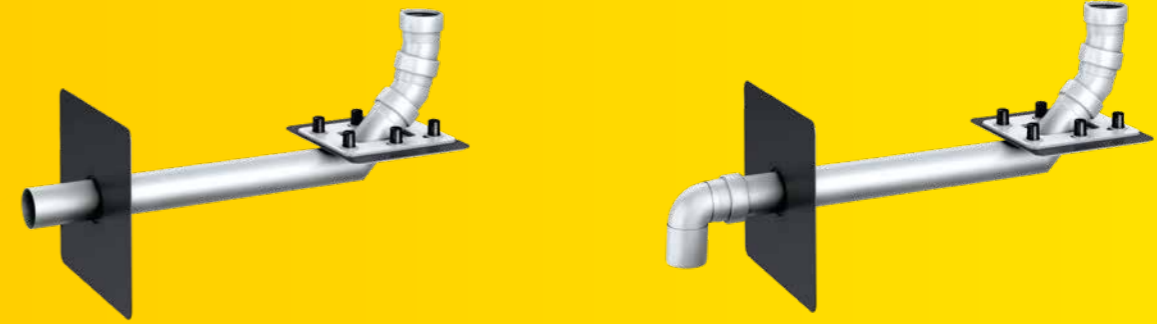

K

Properties

In the past, installing a cascading drainage system has always been a grey area in building law. SitaKaskade Inside is a standard-compliant component system for rain drainage over multiple levels, which is also visually attractive. SitaKaskade Inside conforms with standards and delivers legal certainty for the first time. Component system: Quick, safe installation. Aesthetic solution for challenging architecture: Invisible pipe routing, the terrace surface structure can be individually designed.

- + Legal security for the first time - standard-compliant
- + Planning security and safe installation using component system
- + Concealed pipe installation
- + Free range of options for the individual design of the terrace structure

Installation example

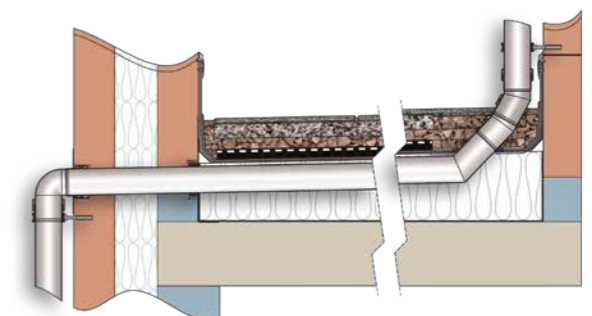

SitaKaskade Inside	DN	OD*	Article number
 as waterspout	70	75	33 03 99

SitaKaskade Inside	DN	OD*	Article number
 for downspout	70	75	33 02 99

Accessories



SitaKaskade Flat

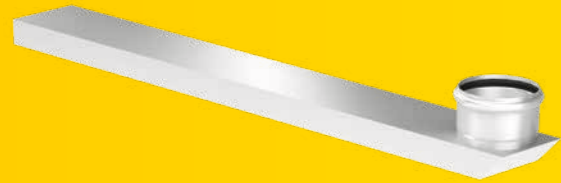

SitaKaskade Flat downpipe holder



SitaKaskade Flat parapet lead-through

Properties

SitaKaskade Flat is the next stage of development of the SitaKaskade Inside. Cascade drainage with high compressive and tensile strength can now be integrated in the system above the waterproof membrane. Standards-compliant cascade drainage remains possible below the slab paving, thanks to a height of just 40 mm, a vertical downpipe holder and a horizontal parapet lead-through.

- + For safe cascade drainage below the slab paving
- + Compatible with the SitaPipe stainless steel pipe system
- + Integrated coupler for easy and reliable connection of the downpipe
- + With adhesive flange for liquid applied waterproofing
- + As waterspout or in combination with the SitaTurbo adapters

Installation example

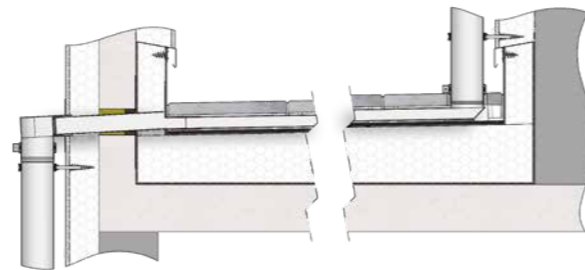

Accessories



SitaTurbo flex vapour barrier plate



SitaTurbo cladding cover plate



SitaTurbo adapter



SitaKaskade Flat bend



SitaKaskade Flat channel



SitaKaskade Flat connector

SitaKaskade Flat	DN	OD*	Length (mm)	Article number
	70	75	1000	33 04 04
	70	75	2000	33 04 05
	100	110	1000	33 04 08
	100	110	2000	33 04 09

SitaKaskade Flat	Length (mm)	Article number
	600	33 04 00

SitaKaskade lead-through fluid



SitaKaskade lead-through fluid

Properties

With the SitaKaskade lead-through, passing pipes through the parapet is much easier and safer. The adhesive flange for liquid applied waterproofing supports all methods to create a safe parapet lead-through. Folded near the edge, the product allows the pipe to be laid directly on the waterproof membrane to provide standards-compliant cascade drainage above the waterproofing layer.

- + To lead the pipe safely through the parapet
- + Compatible with the SitaPipe stainless steel pipe system
- + Integrated socket for easy and reliable connection
- + With adhesive flange for liquid applied waterproofing

Installation example

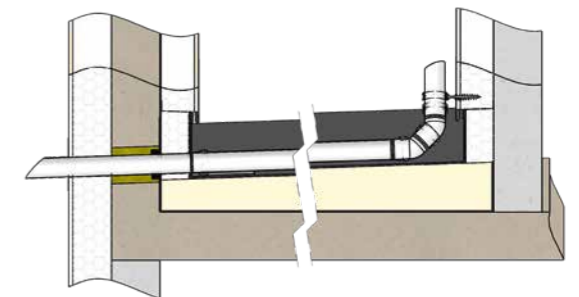

Accessories



SitaAttika cladding cover plate



SitaMore sealing sleeve for WDVS

SitaKaskade lead-through fluid	DN	OD*	Article number
	70	75	18 15 99
	100	110	18 16 99

Sitaleicht. Cascade drainage.



SitaKaskade. The practical component system:

Perfectly planned, module by module, step-by-step.

1

Sita rainwater roof outlets, e.g. SitaDSS Indra or SitaEasy

Siphonic drainage system as main or emergency drainage, available in a complete set.

CD

SD



2

SitaKaskade Inside

For ensuring that rainwater is rerouted reliably from higher to lower roof surfaces.

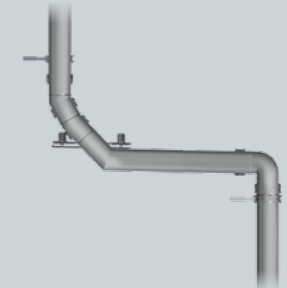

3

SitaPipe stainless steel pipe system

For spanning longer horizontal and vertical flow channels.



BT

for Balcony and Terrace drainage:

For rain - even on very small spaces.

No worries when a shower is looming. Sita's solutions for balcony and terrace drainage protect your balcony and terrace spaces from flooding and backflow - for dry areas and standardcompliant drainage. Its low installation depth and high discharge volume helps even in heavy rainfall incidents. Furthermore, the installation work requires minimal intervention in the existing architectural structure.

SitaCompact



SitaCompact vertical



SitaCompact angled



SitaCompact extension unit



Properties

Small yet particularly efficient balcony outlet versions are required on small flat roofs, terraces, balconies and garages to ensure good drainage due to the fact that constricted space is often the case. The SitaCompact balcony outlet series has been specifically designed for this purpose.

- + Small cross-section - massive capacity
- + Suitable for insulation blocks of 50 mm and thicker
- + With selected connection sleeve
- + Compatible with the SitaCompact screw-on flange
- + With flexible balcony grates

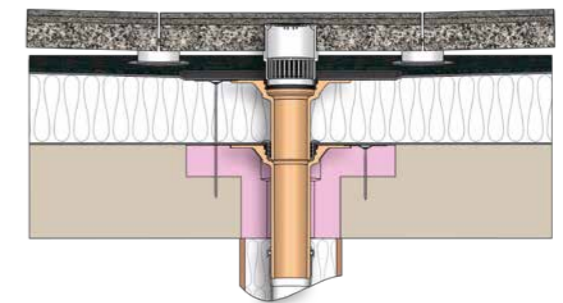
Installation example



SitaCompact	DN	OD*	Article number
 vertical	50	50	19 00 xx**
	70	75	19 02 xx**
 angled	50	50	19 12 xx**
	70	75	19 14 xx**

SitaCompact	Height (mm)	Article number
 extension unit	50-220	19 26 xx**

Accessories



Quality marks



*OD = Outer diameter
**Apart from end number 65, Novoproof with join-in technology.

Important! Specify the selected connection sleeve (xx) in your order (see page 104).

SitaCompact screw-on flange



SitaCompact screw-on flange vertical

SitaCompact screw-on flange angled

SitaCompact screw-on flange extension unit

Properties

Small yet particularly efficient balcony outlet versions are required on small flat roofs, terraces, balconies and garages to ensure good drainage due to the fact that constricted space is often the case. The SitaCompact screw-on flange series of balcony outlets has been specifically designed for this application.

- + Small cross-section - massive capacity
- + Suitable for insulation blocks of 50 mm and thicker
- + With screw-on flange
- + Compatible with the SitaCompact
- + With flexible balcony grates

Installation example

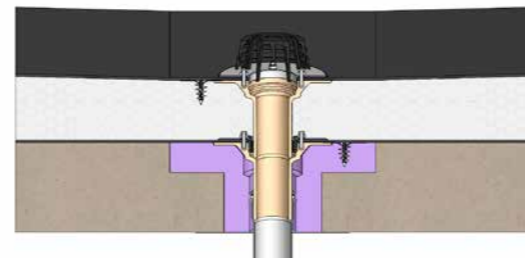

Accessories

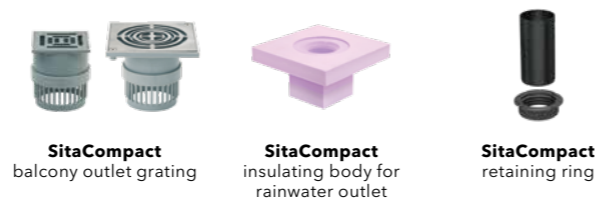

Quality marks



SitaCompact Fluid



SitaCompact Fluid vertical

SitaCompact Fluid angled

SitaCompact Fluid extension unit

Properties

Small yet particularly efficient balcony outlet versions are required on small flat roofs, terraces, balconies and garages to ensure good drainage due to the fact that constricted space is often the case. The SitaCompact balcony outlet series has been specifically designed for this purpose.

- + Small cross-section - massive capacity
- + Suitable for insulation blocks of 50 mm and thicker
- + With liquid applied waterproofing
- + With flexible balcony grates

Installation example

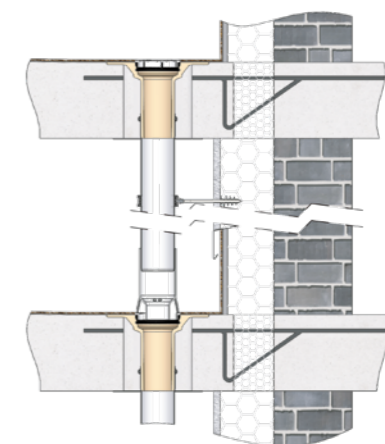

Accessories

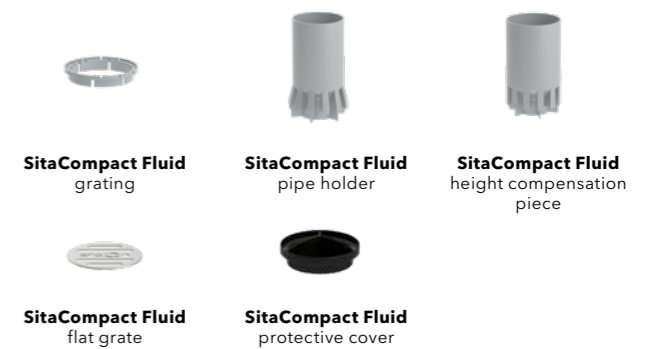

Quality marks



SitaCompact Near



Properties

For used roofs, especially balconies or terraces on top of each other, the confined space means that effective drainage requires small outlets to be installed close to the facade. The SitaCompact Near series was developed for exactly this application. The PUR collar of the SitaCompact Near is slanted, saving valuable centimetres. That means that the outlet and downspout can be positioned very close to the facade, maximising the usable space.

- + Ideal for linear drainage of vertically aligned balconies
- + Specifically for close installation on the cladding
- + Small cross-section - massive capacity
- + With plastic connection sleeve of choice
- + With flexible range of accessories

SitaCompact Near	DN	OD*	Article number
	70	75	19 05 xx

Installation example

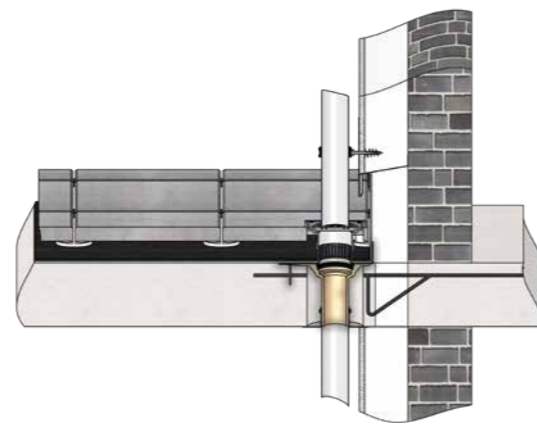

Accessories

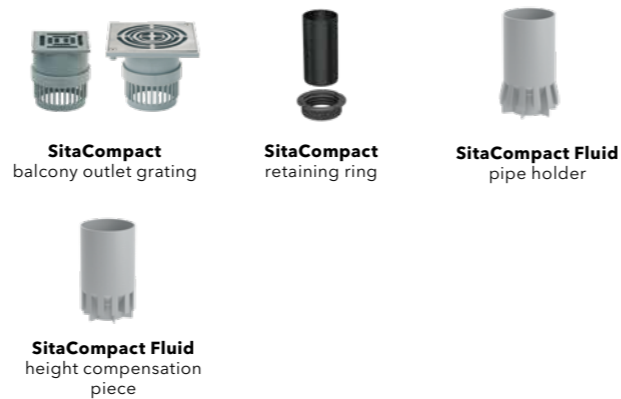

Quality marks



SitaCarport





Properties

If you want to drain a carport properly, a clear view of the underside can become a challenge. The use of a SitaCarport outlet tailored to the available installation combines reliable rainwater drainage with an attractive appearance.

- + The perfect solution for carports
- + With selected connection sleeve
- + Available with a zinc or copper facing cover

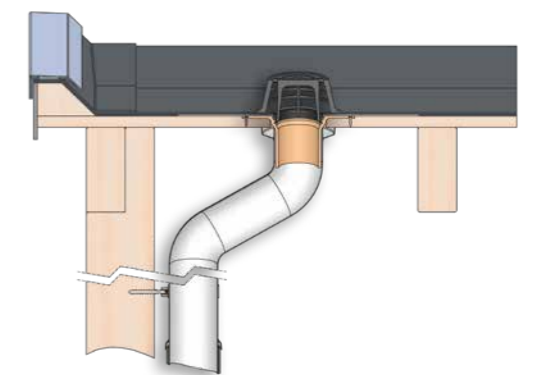
Installation example



SitaCarport + facing cover	Connection	Article number
 copper	for rain fall pipes to DIN EN 612, 6-piece	29 29 xx
 zinc		29 28 xx

SitaConcrete



SitaConcrete



SitaConcrete
end grate

SitaMini

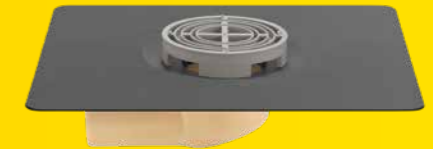

SitaMini
vertical



SitaMini
angled

Properties

No core drilling, no additional time required for installation. The SitaConcrete balcony drain is cast directly into the concrete floor slab of the balconies in the factory or on site. Made of stainless steel, it guarantees durability for the entire service life.

- + TÜV-tested product
- + Verified discharge volumes
- + For direct embedding in concrete
- + Available in five sizes depending on concrete thickness
- + One part, many accessories available

SitaConcrete	Height (mm)	Article number
	140	34 02 14
	160	34 02 16
	180	34 02 18
	200	34 02 20
	220	34 02 22

Installation example

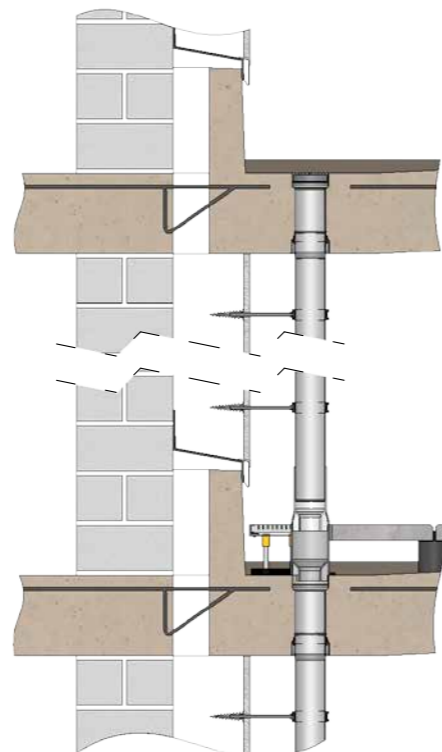



Quality marks



Properties

SitaMini is the name of the multifaceted drainage system, which combines maximum space-saving with optimum functionality. The „Mini“ blends in perfectly.

- + Also applied on garages
- + Can be combined with the SitaMini balcony grate
- + Flexible due to two sizes in one outlet
- + Suitable for versatile use, particularly low

SitaMini	DN	OD*	Article number
 vertical	50	50	16 02 xx**
	70	75	
 angled	50	50	16 12 xx**
	70	75	16 14 xx**

Installation example

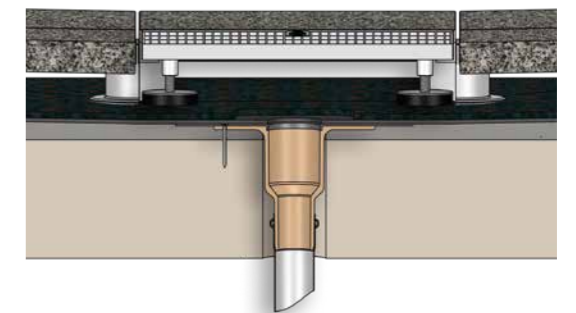

Accessories



SitaMini
balcony outlet grating

*OD = Outer diameter

**Apart from end number 03 (Firestone Quickseam SA Flashing) and 84 (Novoproof with join-in technology).

Sitaleicht. Balcony and terrace drainage.



This is how easy combinations are generated.

Accessories	Product series									
	Sita Compact vertical	Sita Compact angled	Sita Compact screw-on flange vertical	Sita Compact screw-on flange angled	Sita Compact Fluid vertical	Sita Compact Fluid angled	Sita Compact Near	Sita Carport	SitaMini vertical	SitaMini angled
	+									
SitaMore height compensation piece	○	○	○	○	○	○	○		○	○
SitaMore vapour barrier plate	○	○	○	○	○	○	○		○	○
SitaMore vapour barrier plate Duoflex		○		○		○				
SitaAttika cladding cover plate	○	○	○	○	○	○	○		○	○
SitaMore sealing sleeve		○		○		○				○

BT

D

for Drainage:

Get yourself all-round protection!

Sita drainage systems collect rainwater before it gets to the building. Like a modern water trench, the drainage system at ground level protects the interior of your building. The facade is also protected from heavy rainfall splashing back. The drainage system with a grating and frame is sturdy and durable.

SitaDrain® Klassik

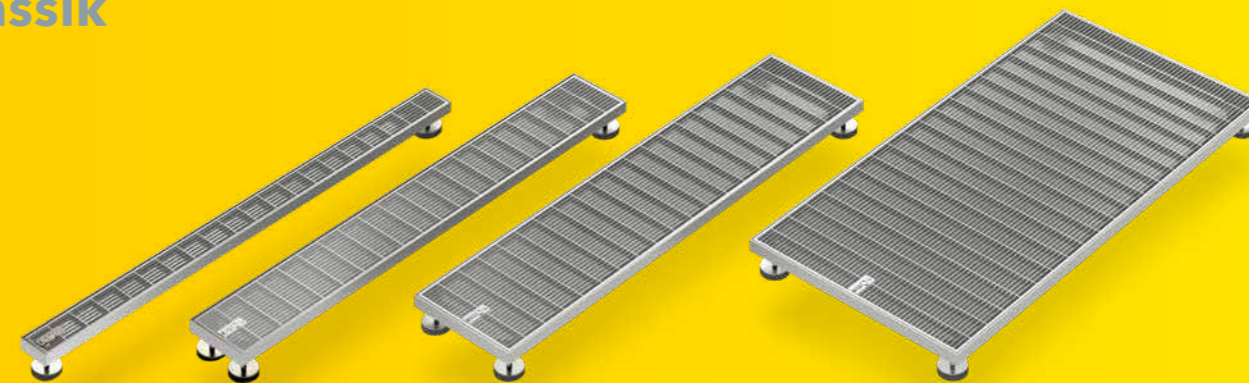

 SitaDrain® Klassik 100 mm width
  SitaDrain® Klassik 150 mm width
  SitaDrain® Klassik 250 mm width
  SitaDrain® Klassik 500 mm width









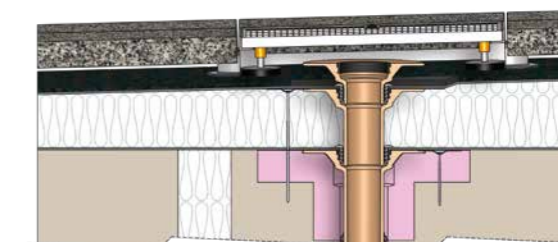

Properties

SitaDrain® is the excellent addition to the drainage systems for balconies, terraces and walkways. The SitaDrain® drainage grating runs like a protective belt around the whole building, catches the water and routes it into the Sita roof or balcony outlets.

- + Large height differences can be bridged
- + Load rating class K 3, can be travelled over in a wheelchair
- + Ideal supplement to roof or balcony outlet
- + Infinitely height-adjustable
- + Different lengths and widths

Installation example



SitaDrain® Klassik	Material	Size (mm)	Article number
	stainless steel	100 x 1000	25 10 10
		150 x 1000	25 15 00
		250 x 1000	25 25 00
	galvanised steel	100 x 750	20 10 75
		100 x 800	20 10 80
		100 x 1000	20 10 00
		150 x 500	20 15 50
		150 x 750	20 15 75
		150 x 1000	20 15 00
		250 x 500	20 25 50
		250 x 1000	20 25 00
	500 x 1000	20 50 00	

SitaDrain® Endlos

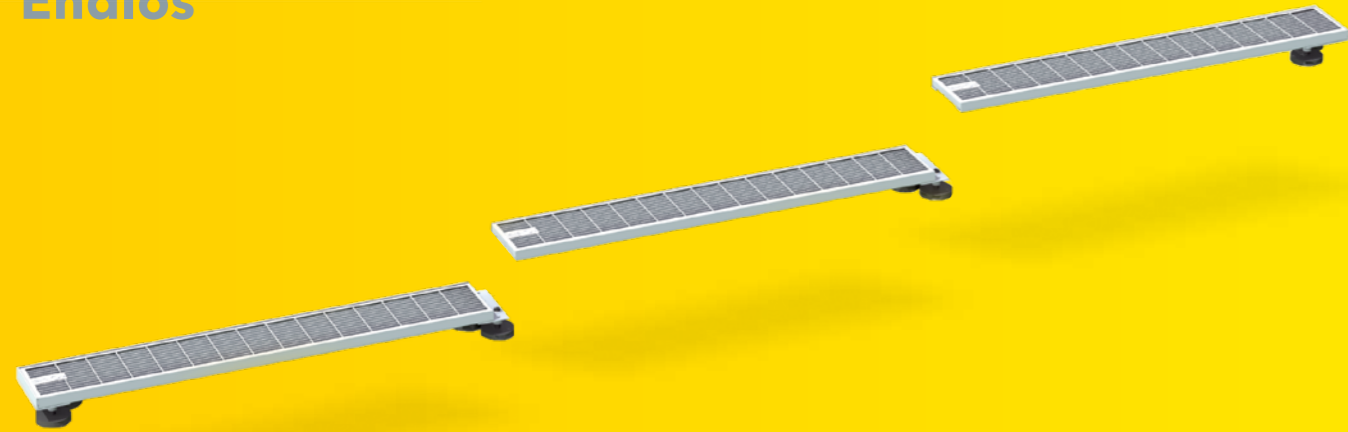

 SitaDrain® Endlos start piece
  SitaDrain® Endlos intermediate piece
  SitaDrain® Endlos end piece

SitaDrain® Terra galvanised steel

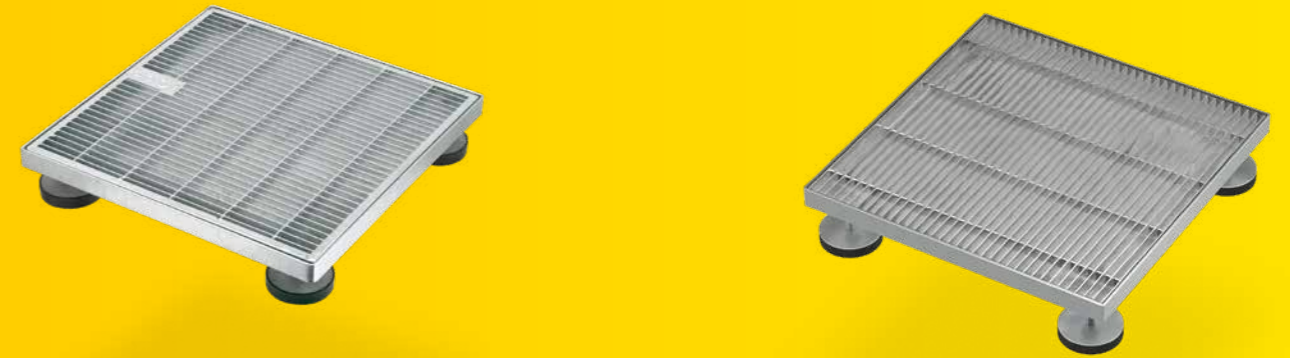

 SitaDrain® Terra with grating
  SitaDrain® Terra with longitudinal bar grating

Properties

SitaDrain® Endlos, the mesh cover system variant, is perfectly matched to the appropriate building. The SitaDrain® Endlos is the perfect supplement to the Sita rainwater outlet range in front of long cladding, window or door elements.

- + Large height differences can be bridged
- + Load rating class K 3, can be travelled over in a wheelchair
- + Ideal supplement to roof or balcony outlet
- + Infinitely height-adjustable
- + Any length is possible

Installation example

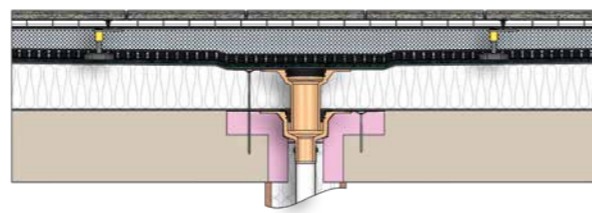

SitaDrain® Endlos	Material	Size (mm)	Article number
 start piece	galvanised steel	150 x 1000	27 15 22
 intermediate piece		150 x 1000	27 15 44
 end piece		150 x 1000	27 15 88

Properties



The Sita Drain® Terra is used as an inspection shaft on terraces and green roofs. Its four infinitely height-adjustable rubber feet give it a secure hold, allowing it to be set to any height level.

- + Large height differences can be bridged
- + Load rating class K 3, can be travelled over in a wheelchair
- + Ideal supplement to roof or balcony outlet
- + Infinitely height-adjustable
- + Different grating designs

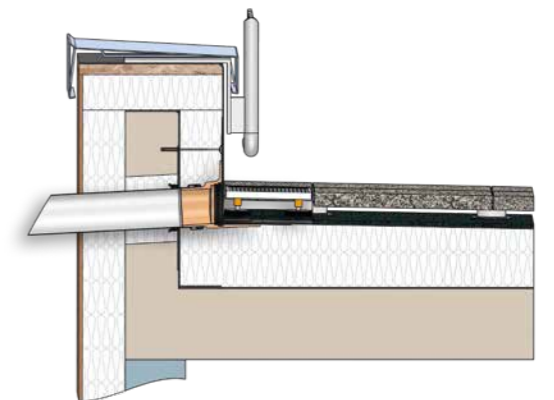
Installation example



SitaDrain® Terra	Designs	Size (mm)	Article number
	Grating	300 x 300	18 90 62*
	Grating	400 x 400	20 40 40
	Longitudinal bargrating	400 x 400	20 40 40 15
	Grating	500 x 500	20 50 50
	Longitudinal bargrating	500 x 500	20 50 50 15

Grate designs			
Grating		Longitudinal bar grating	

SitaDrain® Terra stainless steel

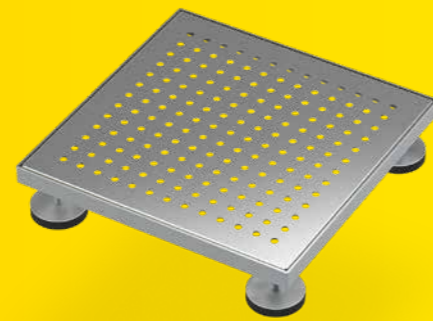
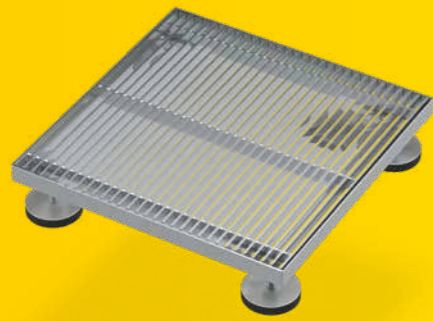

 SitaDrain® Terra
with longitudinal bar grating

 SitaDrain® Terra
with circular

Properties





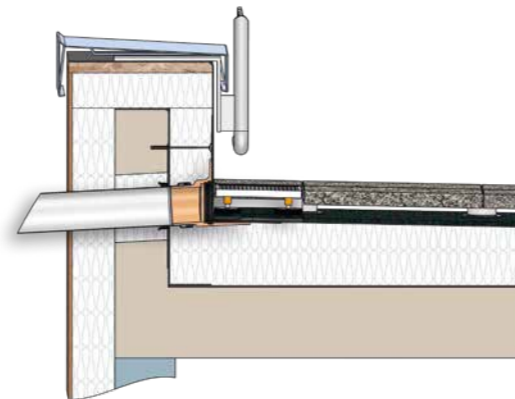

The Sita Drain® Terra is used as an inspection shaft on terraces and green roofs. Its four infinitely height-adjustable rubber feet give it a secure hold, allowing it to be set to any height level.

- + Large height differences can be bridged
- + Load rating class K 3, can be travelled over in a wheelchair
- + Ideal supplement to roof or balcony outlet
- + Infinitely height-adjustable
- + Different grating designs

Installation example



SitaDrain® Terra	Designs	Dimensions (mm)	Article number
	Grating	400 x 400	25 40 40
	Longitudinal bar grating	400 x 400	25 40 40 15
	Circular	400 x 400	25 40 40 11
	Square	400 x 400	25 40 40 12
	Elliptical	400 x 400	25 40 40 13
	Bubble	400 x 400	25 40 40 14
	Grating	500 x 500	25 50 50
	Longitudinal bar grating	500 x 500	25 50 50 15

Grate designs			
Grating		Square	
Longitudinal bar grating		Elliptical	
Circular		Bubble	

SitaDrain® area frame galvanised steel

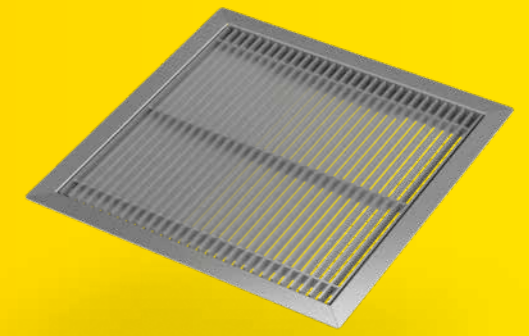
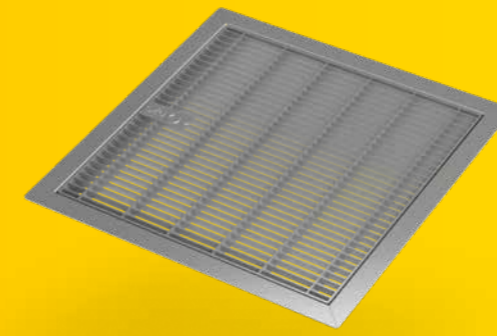

 SitaDrain® area frame
with grating

 SitaDrain® area frame
with longitudinal bar grating

Properties



The SitaDrain® area frame is used as an inspection shaft for outlets on terraces and balconies. Its all-round frame, supported on 4 sides, give it a secure hold, allowing it to be set to any height level. No feet are required, so the maximum usable surface is retained under the component, for example for an emergency drainage outlet.

- + The area frame means easy installation without height adjustment
- + Large height differences can be bridged
- + Ideal supplement to roof or balcony outlet
- + Rust-proof stainless steel or galvanised steel
- + Sits directly on the slab paving
- + Available with different grating designs

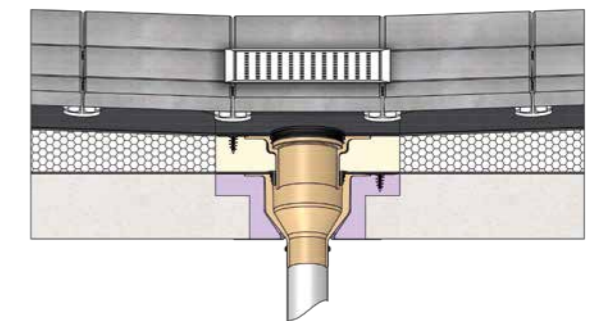
Installation example

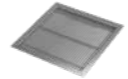

SitaDrain® area frame	Designs	Dimensions (mm)	Article number
	Grating	450 x 450	25 40 40 44
	Longitudinal bar grating	450 x 450	25 40 40 45

Grate designs			
Grating		Longitudinal bar grating	

SitaDrain® area frame stainless steel

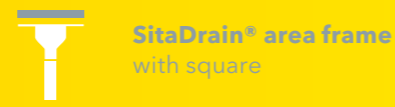
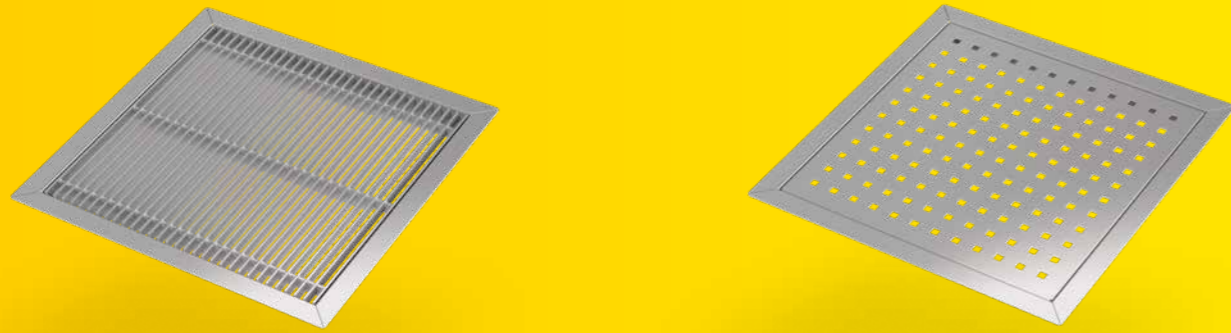

SitaDrain® profile frame galvanised steel

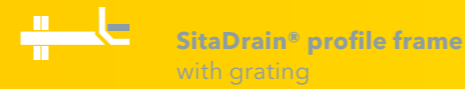
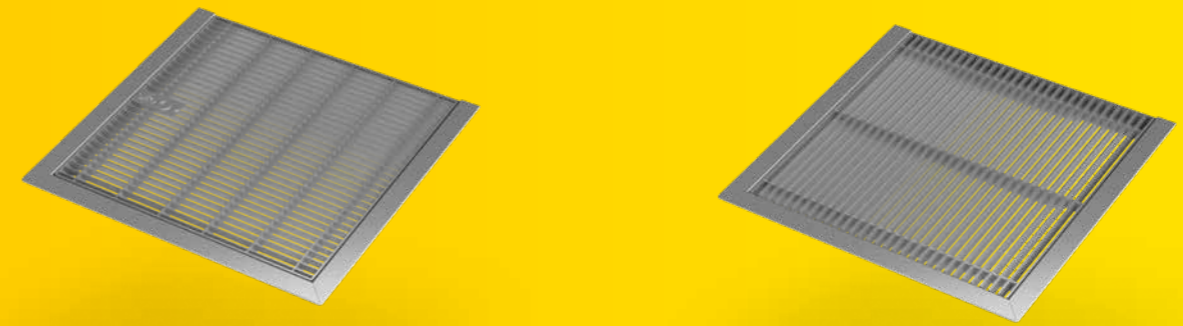

Properties

The SitaDrain® area frame is used as an inspection shaft for outlets on terraces and balconies. Its all-round frame, supported on 4 sides, give it a secure hold, allowing it to be set to any height level. No feet are required, so the maximum usable surface is retained under the component, for example for an emergency drainage outlet.

- + The area frame means easy installation without height adjustment
- + Large height differences can be bridged
- + Ideal supplement to roof or balcony outlet
- + Rust-proof stainless steel or galvanised steel
- + Sits directly on the slab paving
- + Available with different grating designs

Installation example

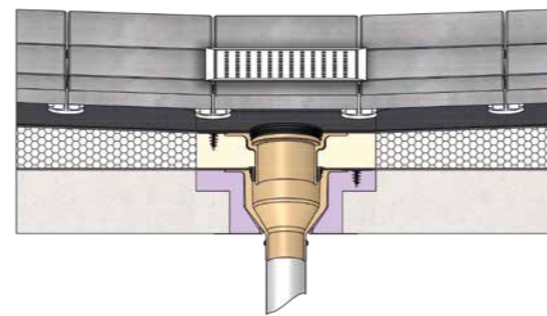

SitaDrain® area frame	Designs	Dimensions (mm)	Article number
	Bubble	450 x 450	25 40 40 43
	Elliptical	450 x 450	25 40 40 42
	Grating	450 x 450	25 40 40 44
	Circular	450 x 450	25 40 40 40
	Longitudinal bar grating	450 x 450	25 40 40 45
	Square	450 x 450	25 40 40 41

Grate designs			
Grating		Square	
Longitudinal bar grating		Elliptical	
Circular		Bubble	

Properties

The SitaDrain® profile frame is a uniquely brilliant solution for balconies and terraces. It is a discrete 23 mm in height and rests on three sides directly on the slab paving so it can run all the way to the parapet. No feet are required, so the maximum usable surface is retained under the component, for example for an emergency drainage outlet.

- + The profile frame means it can also be used with insulation wedges in the parapet area
- + Large height differences can be bridged
- + Ideal supplement to roof or balcony outlet
- + Rust-proof stainless steel or galvanised steel
- + Sits directly on the slab paving
- + Available with different grating designs

Installation example

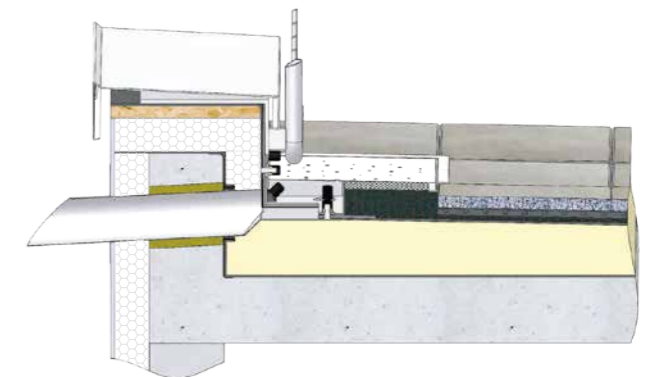

SitaDrain® profile frame	Designs	Dimensions (mm)	Article number
	Grating	425 x 450	25 40 40 34
	Longitudinal bar grating	425 x 450	25 40 40 35

Grate designs			
Grating		Longitudinal bar grating	

SitaDrain® profile frame stainless steel

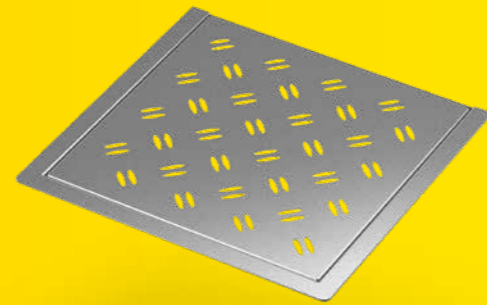
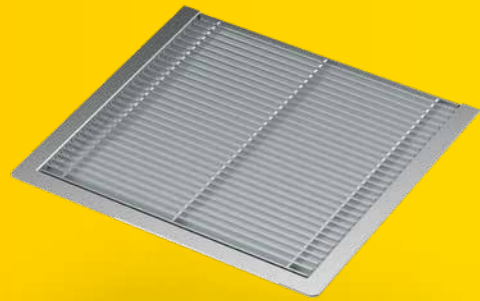

SitaDrain® profile frame with longitudinal bar grating



SitaDrain® profile frame with elliptical

SitaDrain® box drain galvanised steel

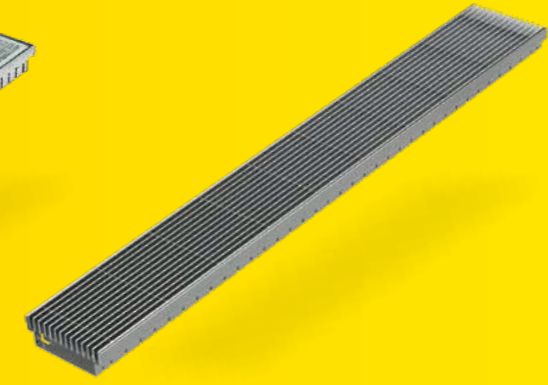
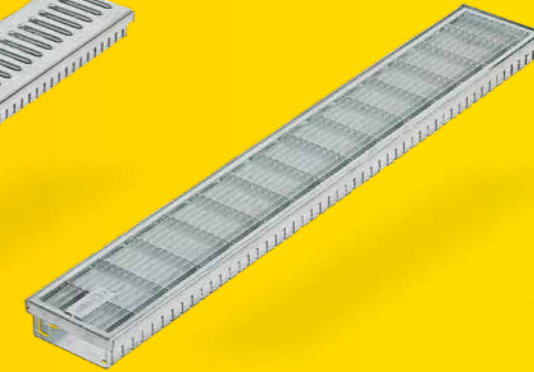
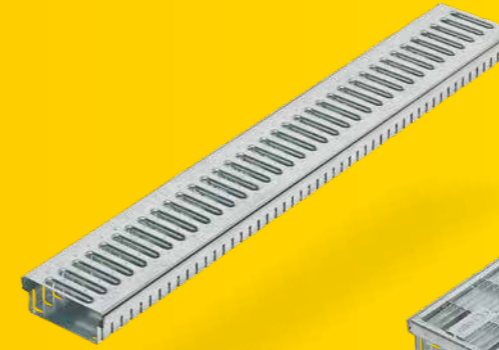

SitaDrain® box drain with footbridge



SitaDrain® box drain with grating



SitaDrain® box drain with longitudinal bar grating

Properties

The SitaDrain® profile frame is a uniquely brilliant solution for balconies and terraces. It is a discrete 23 mm in height and rests on three sides directly on the slab paving so it can run all the way to the parapet. No feet are required, so the maximum usable surface is retained under the component, for example for an emergency drainage outlet.

- + The profile frame means it can also be used with insulation wedges in the parapet area
- + Large height differences can be bridged
- + Ideal supplement to roof or balcony outlet
- + Rust-proof stainless steel or galvanised steel
- + Sits directly on the slab paving
- + Available with different grating designs

Installation example

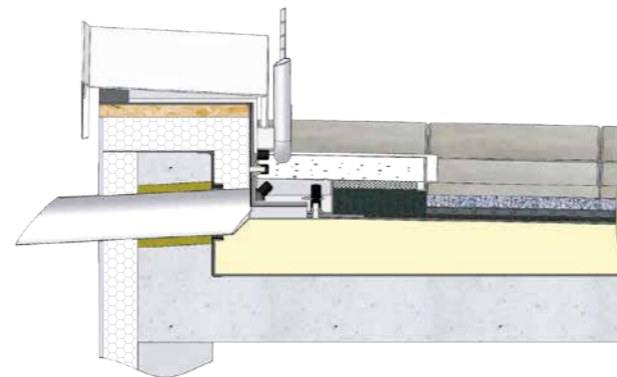

Properties

These Sita drainage variants offer many visual, construction and laying advantages. For example, SitaDrain® box drains can be laid directly on a gravel bed. The box drain components are interconnected for „endless“ laying. Infinite height adjustment is possible using the height adjustment set.

- + For laying on a gravel bed
- + Grating and Longitudinal bar grating for barrierfree transitions
- + Load class K 3 (300 kg, wheelchair accessible)
- + Footbridge, grating and longitudinal bar grating available
- + Heights: 30 mm, 40 mm und 50 mm
- + Dimension: 150 x 1000 mm

Installation example

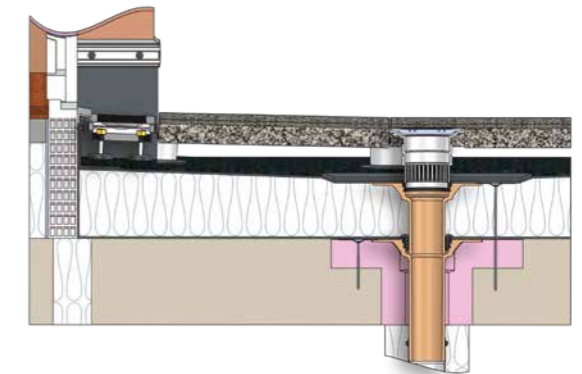

SitaDrain® profile frame	Designs	Dimensions (mm)	Article number
	Grating	400 x 400	25 40 40 34
	Longitudinal bar grating	400 x 400	25 40 40 35
	Circular	400 x 400	25 40 40 30
	Square	400 x 400	25 40 40 31
	Elliptical	400 x 400	25 40 40 32
	Bubble	400 x 400	25 40 40 33

Grate designs			
Grating		Square	
Longitudinal bar grating		Elliptical	
Circular		Bubble	

Designs	Drain height (mm)	Article number
	30	24 15 30
	40	24 15 40
	50	24 15 50
	30	24 15 35
	40	24 15 45
	50	24 15 55
	30	24 30 15
	40	24 40 15
	50	24 50 15

Accessories



SitaDrain® drain height adjustment set



SitaDrain® drain fastening



SitaDrain® drain head piece

SitaDrain® box drain stainless steel

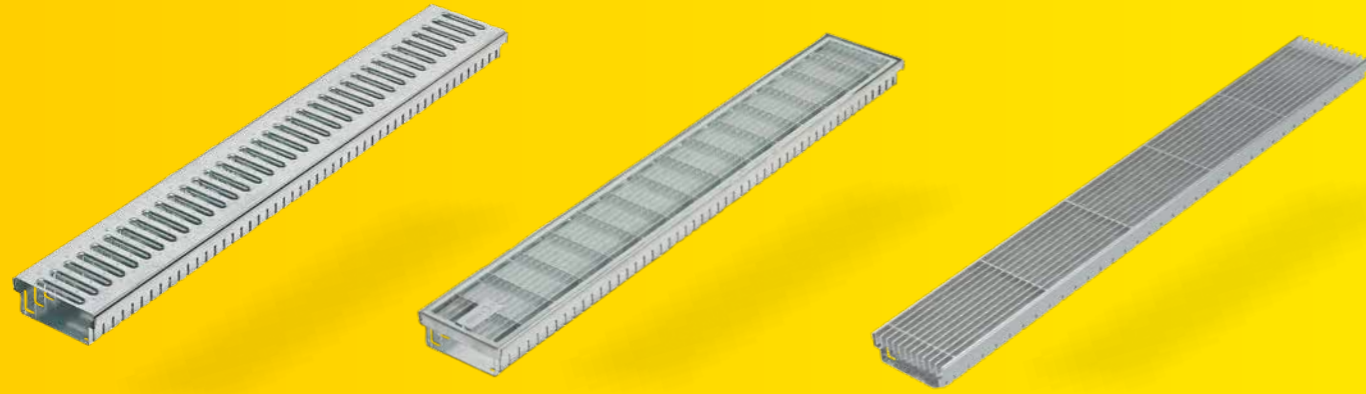

 SitaDrain® box drain with footbridge
  SitaDrain® box drain with grating
  SitaDrain® box drain with longitudinal bar grating

Properties

These Sita drainage variants offer many visual, construction and laying advantages. For example, SitaDrain® box drains can be laid directly on a gravel bed. The box drain components are interconnected for „endless“ laying. Infinite height adjustment is possible using the height adjustment set.

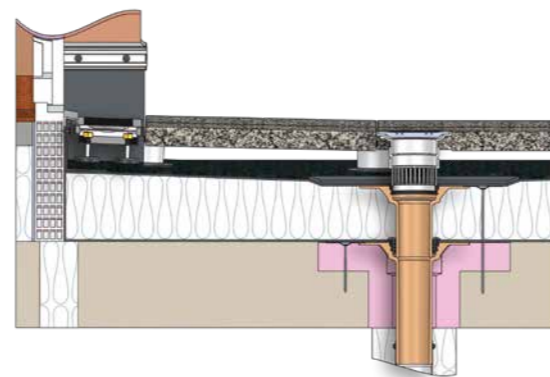

- + For laying on a gravel bed
- + Grating and Longitudinal bar grating for barrierfree transitions
- + Load class K 3 (300 kg, wheelchair accessible)
- + Footbridge, grating and longitudinal bar grating available
- + Heights: 30, 40 und 50 mm
- + Dimension: 150 x 1000 mm

Installation example

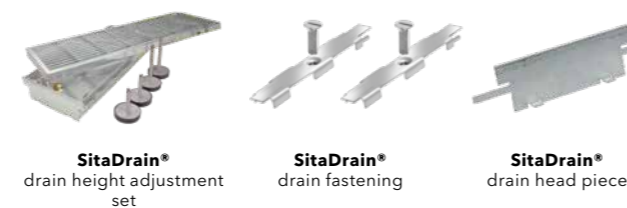

Accessories



Designs		Drain height (mm)	Article number
	Footbridge	30	22 15 30
		40	22 15 40
		50	22 15 50
	Grating	30	22 15 35
		40	22 15 45
		50	22 15 55
	Longitudinal bar grating	30	22 30 15
		40	22 40 15
		50	22 50 15

SitaDrain® box drain with designer grate, stainless steel

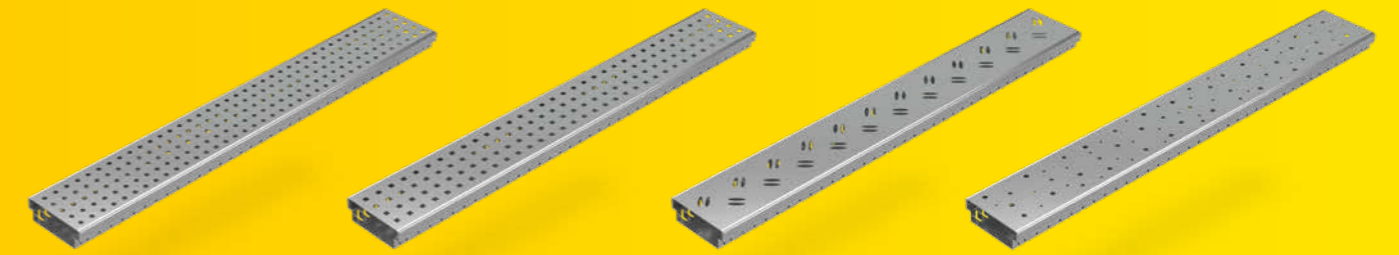

 SitaDrain® box drain with designer grate, Circular
  SitaDrain® box drain with designer grate, square
  SitaDrain® box drain with designer grate, elliptical
  SitaDrain® box drain with designer grate, bubble

Properties

These Sita drainage variants offer many visual, construction and laying advantages. For example, SitaDrain® box drains can be laid directly on a gravel bed. The box drain components are interconnected for „endless“ laying. Infinite height adjustment is possible using the height adjustment set.

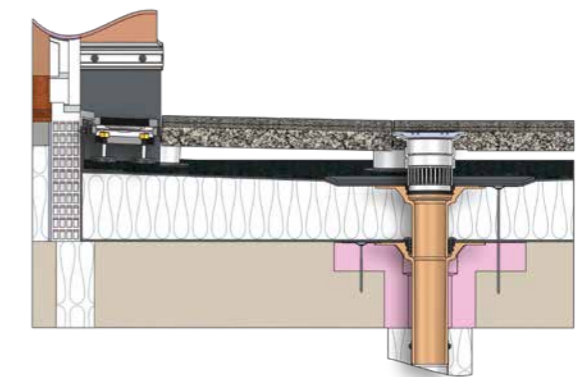

- + For laying on a gravel bed
- + Meets high design standards
- + Load class K 3 (300 kg, wheelchair accessible)
- + Heights: 30, 40 und 50 mm
- + Dimension: 150 x 1000 mm

Installation example

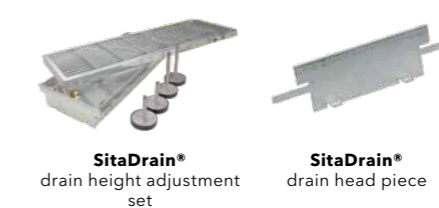

Accessories

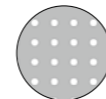
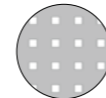

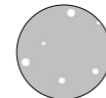
Designs		Drain height (mm)	Article number
	Circular	30	22 30 11
		40	22 40 11
		50	22 50 11
	Square	30	22 30 12
		40	22 40 12
		50	22 50 12
	Elliptical	30	22 30 13
		40	22 40 13
		50	22 50 13
	Bubble	30	22 30 14
		40	22 40 14
		50	22 50 14

SitaDrain® Wood stainless steel

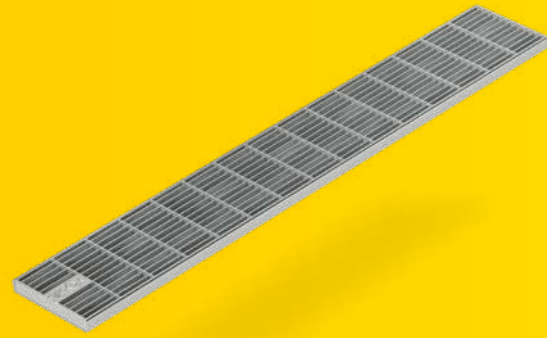

SitaDrain® Wood
with grate

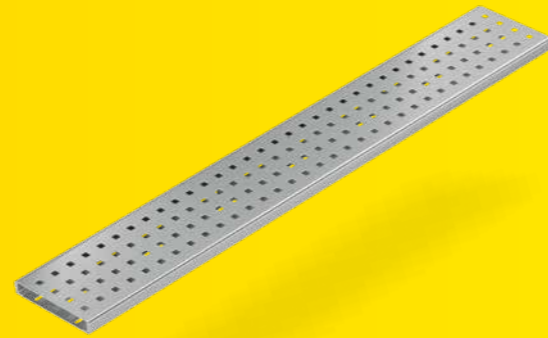

SitaDrain® Wood
with square grate

Properties

The SitaDrain® Wood is used on terraces and balconies with timber or WPC covering. The products of this series have a low installed height, making them perfect for laying directly on the substructure and reliably draining the water. The different grating designs meet the highest design standards.

- + For laying with timber or WPC covering
- + Meets the requirements of load rating class K 3
- + With mesh cover, footbridge or designer grate
- + Made of high quality stainless steel
- + Height: 22 mm

Installation example

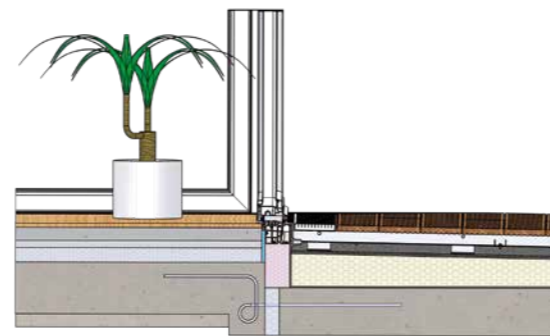

SitaDrain® Wood	Designs	Height (mm)	Article number
	Bubble	22	22 20 14
	Elliptical	22	22 20 13
	Grating	22	22 20 05
	Circular	22	22 20 11
	Square	22	22 20 12
	Footbridge	22	22 20 10

Grate designs			
Grating		Square	
Footbridge		Elliptical	
Circular		Bubble	

Accessories



SitaDrain® Wood
head piece

This is how easy combinations are generated.

Accessories	Product series							
	SitaDrain® Klassik	SitaDrain® Endlos	SitaDrain® Terra	SitaDrain® area frame	SitaDrain® profile frame	SitaDrain® box drain	SitaDrain® Wood	
SitaDrain® hinged feet								
SitaDrain® gravel strip								
SitaDrain® junction channel								
SitaDrain® feet								

G R

for Green roof and Retention:

Specially developed for green roofs as well as for roofs without ballast, the retention solutions cause rainwater to be temporarily retained on the roof. This guarantees controlled discharge of the rainwater for retention roofs. The SitaGreen product family delivers perfect support for green roofs - to discharge rainwater at all levels of the structure.

SitaGreen

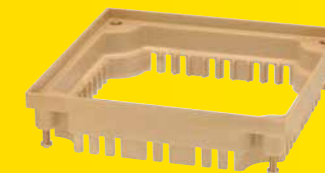

SitaGreen
for intensive greenery



SitaGreen
green roof shaft
for extensive greenery



SitaGreen
extension unit

Properties

The SitaGreen product family is the preferred solution for rainwater drainage on all levels of the layered structure for green roofs. The SitaGreen inspection shafts are suitable for both extensive and intensive roof greenery.

- + Modular inspection shaft
- + Drainage of all layers
- + Suitable for all roof greenery
- + Infinitely height-adjustable
- + Simple installation

Installation example

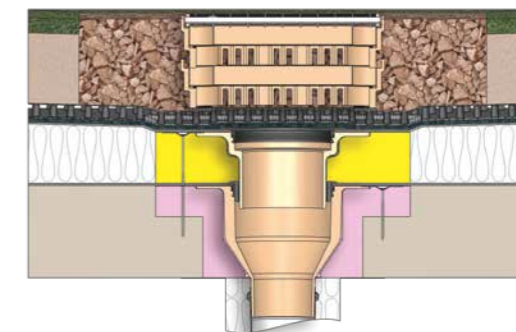

GR

SitaGreen	Height (mm)	Article number
 for intensive greenery	600	23 20 40
	Special height	23 99 99
 green roof shaft	100 - 130	23 00 40
 extension unit	50 - 80	23 10 40

SitaRetention green roof shaft



SitaRetention green roof shaft
 SitaRetention green roof shaft for intensive greenery
 SitaRetention Fix
 SitaRetention retaining element

Properties

Specially developed for restricted flow roofs, SitaMore Retention is installed in a Sita rainwater outlet to ensure that the rainwater can be retained using a specially designed rain retention space. SitaGreen Retention is used as an inspection shaft to prevent the formation of algae and moss.

- + For use in conventional drainage outlets for targeted reduction of water intake
- + Optionally with or without dome grate depending on application
- + Simple insertion in the outlet pot without extra tools
- + With scaled adjusting slide or predefined opening
- + For controlled rainwater drainage

Installation example

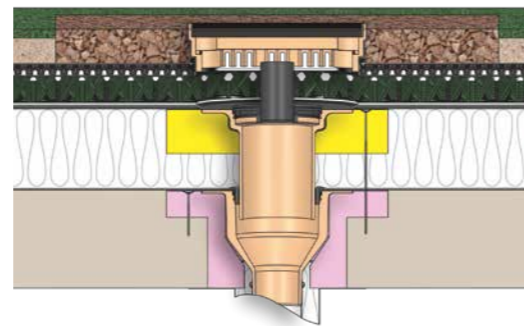

SitaRetention green roof shaft	Height (mm)	Article number
	100 - 120	23 30 40

SitaRetention green roof shaft for intensive greenery	Height (mm)	Article number
	600	23 40 40

SitaRetention Fix	For Series	Article number
	SitaStandard, SitaMulti, Sitalndra	40 91 03
	SitaTrendy	40 91 04

SitaRetention retaining element	For Series	Damming height from-to (mm)	Article number
	SitaStandard, Sitalndra, SitaMulti	25 - 105	10 91 75
		85 - 150	10 91 76
		135 - 200	10 91 77
	SitaTrendy, SitaSani®	25 - 105	15 91 75
		85 - 150	15 91 76
		135 - 200	15 91 77

SitaRetention Twist



SitaRetention Twist with dome grate
 SitaRetention Twist without dome grate

Properties

Specially developed for retention roofs, the SitaRetention product family ensures that the rainwater is retained for a certain period of time on the roof. With SitaRetention Fix or SitaRetention Twist without dome grate, together with the SitaRetention green roof shaft, any green roof can be upgraded to a retention roof. On flat roofs without ballast, SitaRetention Twist with dome grate efficiently reduces the load on ground pipelines during heavy rainfall events. This guarantees controlled discharge of the rainwater for retention roofs.

- + For use in conventional drainage outlets for targeted reduction of water intake
- + For foil roofs with dome grate, for green roofs with green roof shaft
- + Simple insertion in the outlet pot without extra tools
- + With scaled adjusting slide or predefined opening
- + For controlled rainwater drainage

Installation example

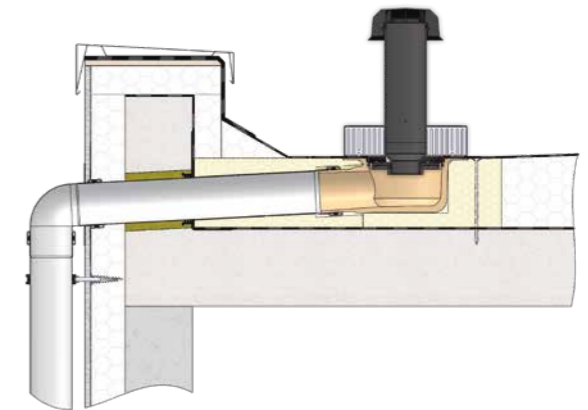

















SitaRetention Twist	For Series	Article number
	SitaStandard, Sitalndra	40 92 01
	SitaTrendy	40 92 03

SitaRetention Twist	For Series	Article number
	SitaStandard, Sitalndra	40 92 02
	SitaTrendy	40 92 04

Sitaleicht. Green roof and Retention.



This is how easy combinations are generated.

Accessories	Product series			
	SitaGreen green roof shaft	SitaGreen intensive greenery	SitaRetention green roof shaft	SitaRetention green roof shaft for intensive greenery
				
SitaGreen extension unit				
SitaRetention Fix				
SitaRetention retaining element				
SitaRetention Twist without dome grate				

GR

R

for Refurbishment:

The older the roof, the greater the risk.

Keep an eye on the condition of your roof at all times with Sita. Flat roof refurbishment is required more and more frequently. There are lots of reasons for this - changed regulations, leaking old rainwater outlets and pipelines, damaged roof skin and even saturated insulation. Statutory regulations mean that thermal insulation has to be topped up. As your refurbishment partner we can help you to update your drainage system – and comply with the required standards.

SitaSani®



SitaSani®
63/90/105



SitaSani® 70

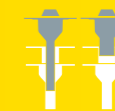

SitaSani® 95

Properties

The SitaSani® problem solver with a long spigot and sealing ring. This compensates for the existing waterproofing and insulation layers to the rainwater outlet or fall pipe in place. Multicompatible for almost any make of rainwater outlet, the rainwater outlets of this series can solve almost any refurbishment task. The various sealing rings are used to match the existing internal diameters. The integrated and additionally fixed selected connection sleeve offers a homogeneous connection to the roof seal.

- + Backflow safe up to a water column of 2 metres
- + To refurbish rainwater outlets and for refurbishment down into the fall pipe
- + With selected connection sleeve
- + Can be installed and sealed very quickly

Installation example

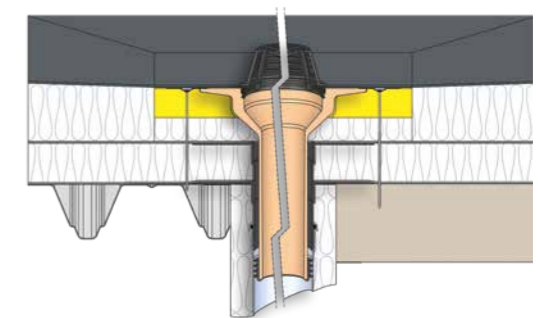

Quality marks



SitaSani®	Backflow safe for internal diameters from-to (mm)	Spigot length (mm)	Article number
 63/90/105	68-86	550	10 63 xx
	98-107	550	10 32 xx
	105-134	550	10 33 xx
 70	82-103	255	10 36 xx
 95	100-140	250	10 28 xx
	100-140	500	10 38 xx

SitaSani®

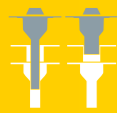

SitaSani® 115



SitaSani® 125



SitaSani® 165

SitaSani® screw-on flange



SitaSani® 63/90/105
screw-on flange



SitaSani® 70
screw-on flange

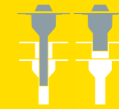

SitaSani® 165
screw-on flange

Properties

The SitaSani® problem solver with a long spigot and sealing ring. This compensates for the existing waterproofing and insulation layers to the rainwater outlet or fall pipe in place. Multicompatible for almost any make of rainwater outlet, the rainwater outlets of this series can solve almost any refurbishment task. The various sealing rings are used to match the existing internal diameters. The integrated and additionally fixed selected connection sleeve offers a homogeneous connection to the roof seal.

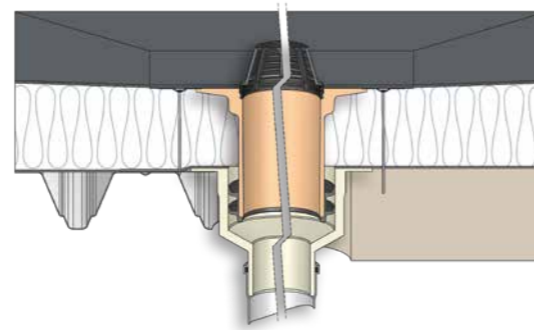

- + Backflow safe
- + To refurbish rainwater outlets and for refurbishment down into the fall pipe
- + With selected connection sleeve
- + Can be installed and sealed very quickly

Installation example



Quality marks



SitaSani®	Backflow safe for internal diameters from-to (mm)	Spigot length (mm)	Article number
 115	115-130	255	10 35 xx
 125	134-168	250	10 27 xx
	134-168	550	10 37 xx
 165	165-205	200	10 29 xx
	165-205	550	10 40 xx

Properties

The SitaSani® screw-on flange problem solver with a long spigot and sealing ring. This compensates for the existing waterproofing and insulation layers to the rainwater outlet or fall pipe in place. Multi-compatible for almost any make of rainwater outlet, the rainwater outlets of this series can solve almost any refurbishment task. The various sealing rings are used to match the existing internal diameters.

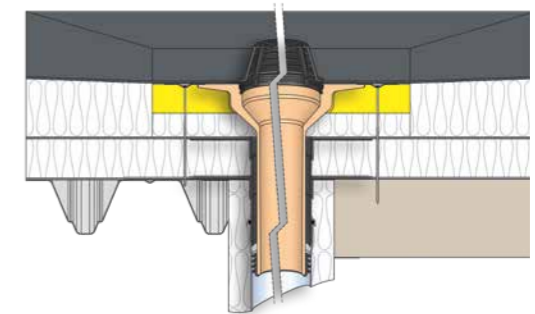

- + Backflow safe
- + To refurbish rainwater outlets and for refurbishment down into the fall pipe
- + With loose-fixed flange construction
- + Can be installed and sealed very quickly

Installation example



Quality marks



SitaSani® screw-on flange	Backflow safe for internal diameters from-to (mm)	Spigot length (mm)	Article number
 63/90/105	68-86	550	10 63 99
	98-107	550	10 32 99
	105-134	550	10 33 99
 70	82-103	255	10 36 99
 165	165-205	550	10 40 99

SitaSani® 160 DSS



SitaSani® 160 DSS



SitaSani® 160 DSS
screw-on flange

Properties

For the refurbishment of siphonic drainage rainwater outlets in place with a pot diameter of 160 mm, the SitaSani® 160 DSS can easily bridge the thermal insulation. The relevant Airstop prevents the unwanted ingress of air, thus ensuring that the pipe system in place is completely filled. The integrated and fixed selected connection sleeve delivers a homogeneous connection to the roof seal. The SitaSani® DSS 160 is also available in a screw-on flange version.

- + For siphonic drainage rainwater outlets in place with a pot diameter of 160 mm
- + With Airstop for siphonic drainage
- + With either with loose-fixed flange design or selected connection sleeve
- + Can be installed and sealed very quickly

Installation example

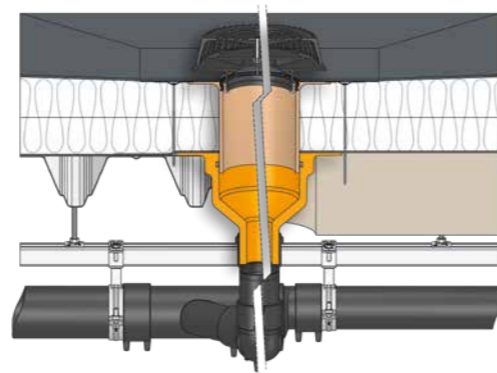

Quality marks



SitaSani® 160 DSS	Spigot length (mm)	Article number
	200	10 60 xx
	550	10 61 xx
	550	10 61 99

This is how easy combinations are generated.

SitaSani® refurbishment outlet	Backflow safe for refurbishment internal diameters* from - to (mm)		Component length (mm)	Pot height (mm)	Article number
	Lip sealing ring	Profiled sealing ring			
SitaSani® 63	68-86	-	550	81	10 63 xx
					10 63 99
SitaSani® 70	82-103	-	255	44	10 36 xx
					10 36 99
SitaSani® 90	98-107	-	550	105	10 32 xx
					10 32 99
SitaSani® 95	100-110	107-140	250	35	10 28 xx
		107-140	550	35	10 38 xx
SitaSani® 105	105-134	-	550	105	10 33 xx
					10 33 99
SitaSani® 115	115-130	-	255	45	10 35 xx
SitaSani® 125	134-144	140-168	250	17	10 27 xx
		140-168	550	17	10 37 xx
SitaSani® 165	165-178	178-205	200	19	10 29 xx
		178-205	550	60	10 40 xx
					10 40 99

Accessories	Product series									
	SitaSani® 63/90/105	SitaSani® 63/90/105 screw-on flange	SitaSani® 70	SitaSani® 70 screw-on flange	SitaSani® 95	SitaSani® 115	SitaSani® 125	SitaSani® 165	SitaSani® 165 screw-on flange	
SitaMore terrace kit										
SitaCompact balcony outlet gratings										
SitaTrendy extension unit										
SitaCompact extension unit										
SitaSani® 95										
SitaSani® insulating body										

V

for Ventilation and pipe fairlead:

Your building needs ventilation!

A well coordinated system is required to ensure your building can breathe in and out. Our ventilation pipes are integral and provide a perfect connection. We supply you with a comprehensive aeration solution. As your partner for ventilation components, Sita will supply the components you need – whether it is for room, section or cold roof ventilation. Durable, sealed material helps you achieve simple, solid vent solutions from Sita – for a single or dual skin roof.

SitaVent



 SitaVent system vent



 SitaVent pipe fairlead



 SitaVent cold roof vent

Properties SitaVent system vent

The SitaVent system vent is the secure roof connection for all room and section ventilation. The base plate including the integrated selected connection sleeve can cover almost every sealing connection. A multi-lip seal provides backflow safety up to a water column of 2 m.

- + With integrated selected connection sleeve
- + Can be supplied as cable and pipe fairlead
- + With removable 180° bend
- + Can be combined with the SitaVent vapour barrier cap

Properties SitaVent pipe fairlead

Made from polyurethane in sizes DN 100 or DN 150. The SitaVent pipe fairlead is supplied with an integrated selected connection sleeve to match the roofing membrane, including rain rejector and removable 87.3° bend.

- + With integrated selected connection sleeve
- + Can be supplied as cable and pipe fairlead
- + With two removable 87.3° bends
- + Can be combined with the SitaVent vapour barrier cap

Properties SitaVent cold roof vent

SitaVent cold roof vent made from polyurethane, thermally insulated, with integrated selected connection sleeve, with rain rejector, sealing ring and rain cover. Height 400 mm.

- + For cold roof ventilation
- + With integrated selected connection sleeve
- + In sizes DN 100 and DN 150

DN	Connecting pipe (mm)	Base plate DN	Article number
70	1000	100	17 42 xx
90	1000	100	17 43 xx
100	1000	100	17 45 xx
125	1000	150	17 46 xx
150	1000	150	17 49 xx

DN	Connecting pipe (mm)	Base plate DN	Article number
100	1000	100	17 65 xx
150	1000	150	17 68 xx

DN	Article number
100	17 74 xx
150	17 78 xx

SitaVent refurbishment vent



Properties

The SitaVent refurbishment vent secures the transition into the old vent pipe to be refurbished. It is supplied as a set, containing all the required components. These include the base plate with selected connection sleeve, the rejector and the refurbishment vent pipe with an adapter to the pipe being refurbished and matching multiple-lip EPDM rubber seal. A new warm roof structure can be completed with an additional base plate.

- + For room and section ventilation
- + With integrated selected connection sleeve
- + Connection to all functional layers
- + For pipe diameters up to 205 mm

Installation example

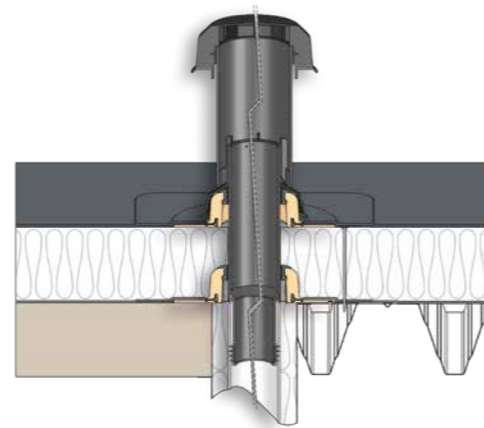

SitaVent refurbishment vent	OD*	Backflow safe from (mm)	Base plate DN	Article number
	63	68-86	100	17 30 xx
	75	82-103	100	17 31 xx
	90	98-107	100	17 32 xx
	110	115-130	100	17 33 xx
	125	140-168	150	17 34 xx
	160	178-205	150	17 35 xx

SitaVent



Properties SitaVent Revision

Vapour barrier under control. Is the vapour barrier actually dry? The new SitaVent Revision allows a quick check of the status below the thermal insulation at any time. Always in demand from the market, Sita developed the new revision component on the basis of the approved SitaVent.

- + To inspect the vapour barrier
- + Including fixing for a thermal insulation core
- + Alternatively to support a thermo-hygrometer
- + With integrated selected connection sleeve
- + Secures the vapour barrier cap with a pipe clip

SitaVent Revision	DN	Article number
	100	17 80 xx
	150	17 81 xx

Installation example SitaVent Revision

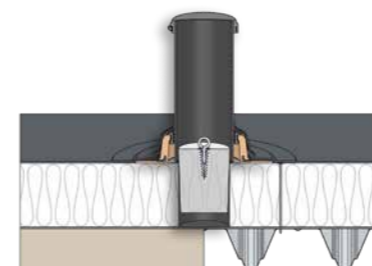

Properties SitaVent condensation deflector

SitaVent condensation deflector: Fully sealed. Moisture is the enemy of any structure. That is why Sita developed the new SitaVent condensation deflector which prevents condensation dripping through the vent pipe back into the building. This product extension is used with the SitaVent system bent and/or SitaVent refurbishment vent.

- + Simple installation
- + Secure fixing against wind loads
- + Condensation is discharged straight onto the waterproofing
- + Suitable for SitaVent pipes DN 100

SitaVent condensation deflector	Component length (mm)	Article number
	400	17 12 00



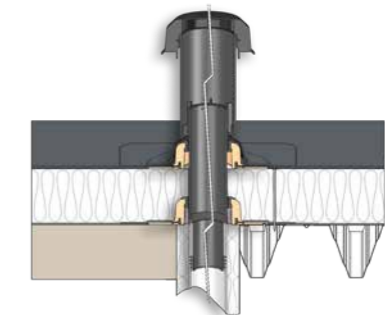



Installation example SitaVent condensation deflector



Sitaleicht. Ventilation and pipe fairlead.

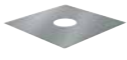
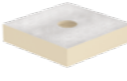
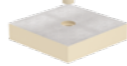

This is how easy combinations are generated.

Accessories		Product series						
		SitaVent system vent		SitaVent refurbishment vent		SitaVent pipe fairlead	SitaVent cold roof vent	SitaVent Revision
		DN 70-100	DN 125-150	DN 63-110	DN 125-160			
SitaVent base plate		DN 100						
		DN 150						
SitaVent rain cover		DN 100						
		DN 150						
SitaPipe PP pipe		DN 100						
		DN 150						
SitaVent protective grating								
SitaVent pipe bend								
SitaVent condensation deflector								
SitaVent vapour barrier cap								
SitaMore reinforcement plate								
SitaVent insulating body								
SitaVent Revision insulating body								

Sitaleicht. Check it out online: sita-bauelemente.de/gb/

FFP

for Fire Protection:

Don't give fire any space!

All-round cover - not just when it rains – if there is a fire as well. Sita Fire protection solutions prevent the dangerous spread of fire and radiated heat. Whether there is a fire at the bottom or at the top or fire pockets in the roof structure - they are all prevented from passing through drainage and ventilation components. If you are unlucky enough to have a fire, the roof layer package protects your roof from its spread – with solutions from Sita.

SitaFireguard®



SitaFireguard®
with dome grate



SitaFireguard®
with retaining element

Properties

Double protection: from water and from fire. What's behind the stable protection provided by the new SitaFireguard® outlets and vents? It's a simple but genius idea: a smart fire protection sleeve permanently attached to the reinforcement plate for trapezoidal steel roofs. Also: Installation is possible entirely from the roof itself.

- + For preventive fire safety to DIN 18234
- + As a full set it provides an easy and safe installation
- + Small roof penetrations thanks to optimised shape of the PE-base body
- + Optimised backflow safety thanks to perfectly seated seal
- + With integrated selected connection sleeve
- + For main and emergency rainwater roof drainage

Installation example

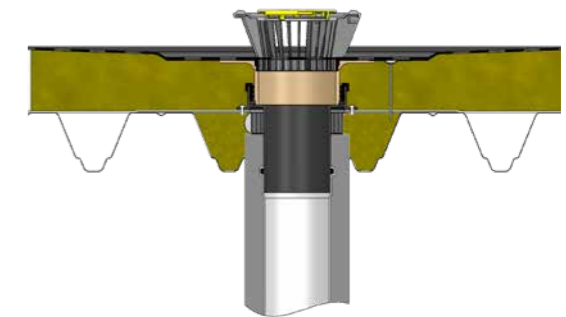

Quality marks



Sita Fireguard®	DN	OD*	Insulation thickness (mm)	Article number
 with dome grate	70	75	65-210	F30 27 xx
			105-570	F30 28 xx
	100	110	65-210	F30 31 xx
			105-570	F30 32 xx
	125	125	65-210	F30 35 xx
			105-570	F30 36 xx
	150	160	65-210	F30 39 xx
			105-570	F30 40 xx

Sita Fireguard®	DN	OD*	Insulation thickness (mm)	Article number
 with retaining element	70	75	65-210	F30 29 xx
			105-570	F30 30 xx
	100	110	65-210	F30 33 xx
			105-570	F30 34 xx
	125	125	65-210	F30 37 xx
			105-570	F30 38 xx
	150	160	65-210	F30 41 xx
			105-570	F30 42 xx

*OD = Outer diameter

Important! Specify the selected connection sleeve (xx) in your order (see page 104). 87

SitaFireguard® screw-on flange



SitaFireguard®
screw-on flange
with dome grate



SitaFireguard®
screw-on flange
with retaining element

Properties

Double protection: from water and from fire. What's behind the stable protection provided by the new SitaFireguard® outlets and vents? It's a simple but genius idea: a smart fire protection sleeve permanently attached to the reinforcement plate for trapezoidal steel roofs. Also: Installation is possible entirely from the roof itself.

- + For preventive fire safety to DIN 18234
- + As a full set it provides an easy and safe installation
- + Small roof penetrations thanks to optimised shape of the PE-base body
- + Optimised backflow safety thanks to perfectly seated seal
- + With integrated selected connection sleeve
- + For main and emergency rainwater roof drainage

Installation example

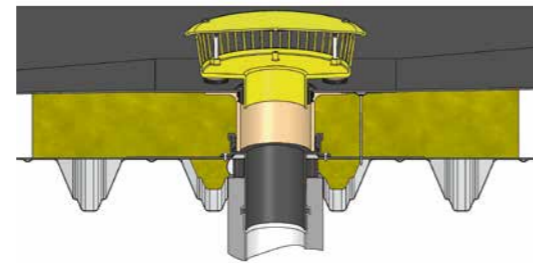

Quality marks



SitaFireguard® screw-on flange	DN	OD*	Insulation thickness (mm)	Article number
	70	75	105-570	F302899
	100	110	105-570	F303299
	125	125	105-570	F303699
	150	160	105-570	F304099

SitaFireguard® screw-on flange	DN	OD*	Insulation thickness (mm)	Article number
	70	75	105-570	F30 30 99
	100	110	105-570	F30 34 99
	125	125	105-570	F30 38 99
	150	160	105-570	F30 42 99

SitaDSS Fireguard®



SitaDSS Fireguard®
with Airstop



SitaDSS Fireguard®
with retaining element

Properties

Double protection: from water and from fire. What's behind the stable protection provided by the new SitaFireguard® outlets and vents? It's a simple but genius idea: a smart fire protection sleeve permanently attached to the reinforcement plate for trapezoidal steel roofs. Also: Installation is possible entirely from the roof itself.

- + For preventive fire safety to DIN 18234
- + As a full set it provides an easy and safe installation
- + Small roof penetrations thanks to optimised shape of the PE-base body
- + Optimised backflow safety thanks to perfectly seated seal
- + With integrated selected connection sleeve
- + For main and emergency rainwater roof drainage

Installation example

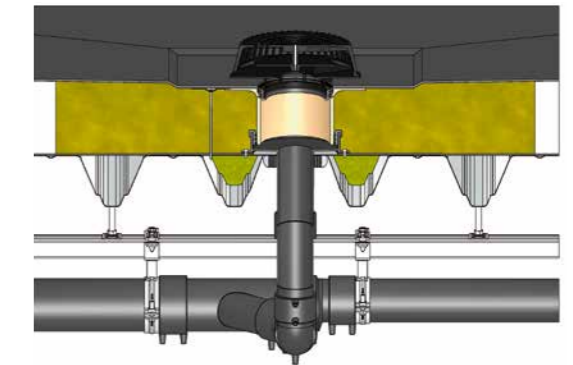

Quality marks



SitaDSS Fireguard®	DN	OD*	Insulation thickness (mm)	Article number
	70	75	65-210	F30 23 xx
			105-570	F30 24 xx

SitaDSS Fireguard®	DN	OD*	Insulation thickness (mm)	Article number
	70	75	65-210	F30 25 xx
			105-570	F30 26 xx

SitaDSS Fireguard® screw-on flange



SitaDSS Fireguard®
screw-on flange
with Airstop



SitaDSS Fireguard®
screw-on flange
with retaining element

SitaVent Fireguard®



SitaVent Fireguard®

Properties

Double protection: from water and from fire. What's behind the stable protection provided by the new SitaFireguard® outlets and vents? It's a simple but genius idea: a smart fire protection sleeve permanently attached to the reinforcement plate for trapezoidal steel roofs. Also: Installation is possible entirely from the roof itself.

- + For preventive fire safety to DIN 18234
- + As a full set it provides an easy and safe installation
- + Small roof penetrations by streamlined design of the PE-base body
- + Optimised backflow safety thanks to perfectly seated seal
- + With integrated selected connection sleeve
- + For main and emergency rainwater roof drainage

Installation example

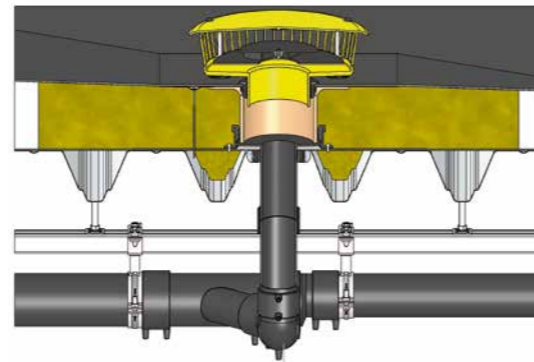

Quality marks



SitaDSS Fireguard® screw-on flange	DN	OD*	Insulation thickness (mm)	Article number
 with Airstop	70	75	105-570	F30 24 99

SitaDSS Fireguard® screw-on flange	DN	OD*	Insulation thickness (mm)	Article number
 with retaining element	70	75	105-570	F30 26 99

Properties

Double shelter: from water and also from fire. But what is the reliable protection provided by the new SitaFireguard® rainwater drainage outlets and roof vents based on? On an idea that is as simple as it is ingenious: a smart fire protection sleeve, firmly connected to the reinforcing plate for steel trapezoidal roofs. Yet another advantage: the installation can take place completely from the rooftop.

- + For preventive fire safety to DIN 18234
- + As a full set it provides an easy and safe installation
- + Small roof penetrations thanks to optimised shape of the PE-base body
- + With integrated selected connection sleeve
- + For room and sewer ventilation

Installation example

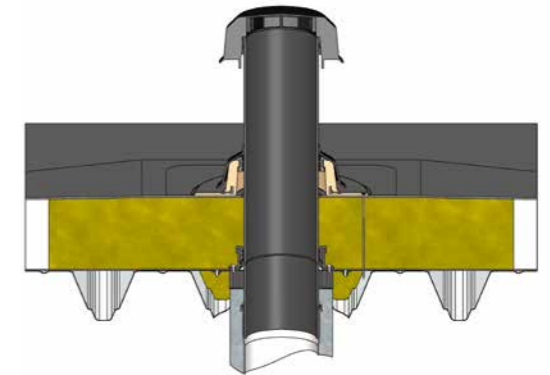

SitaVent Fireguard®	DN	OD*	Insulation thickness (mm)	Article number
	70	75	60-450	F30 43 xx
	100	110	60-450	F30 44 xx
	125	125	60-450	F30 45 xx
	150	160	60-450	F30 46 xx

SitaVent Fireguard® with stainless steel pipe



SitaVent Fireguard®
with stainless steel pipe

SitaFireguard® pipe fairlead



SitaFireguard®
pipe fairlead

Properties

Double shelter: from water and also from fire. But what is the reliable protection provided by the new SitaFireguard® rainwater drainage outlets and roof vents based on? On an idea that is as simple as it is ingenious: a smart fire protection sleeve, firmly connected to the reinforcing plate for steel trapezoidal roofs. Yet another advantage: the installation can take place completely from the rooftop.

- + For preventive fire safety to DIN 18234
- + For roofs out of polyurethane insulation
- + As a full set it provides an easy and safe installation
- + Small roof penetrations thanks to optimised shape of the spigot
- + With integrated selected connection sleeve
- + For room and sewer ventilation

SitaVent Fireguard® with stainless steel pipe	DN	OD*	Insulation thickness (mm)	Article number
	70	75	80-450	F30 47 xx
	100	110	80-450	F30 48 xx
	125	125	80-450	F30 49 xx
	150	160	80-450	F30 50 xx

Properties

The SitaFireguard® pipe lead-through is the secure roof connection for all cable and media lead-throughs on used and unused flat roofs with DIN 18234 fire protection requirements. The base plate including the foamed-in connection sleeve of choice can cover almost every sealing connection. A multi-lip seal provides backflow protection up to a water column of 2 m. The integrated fire protection plug prevents the spread of fire onto the roof.

- + For preventive fire safety to DIN 18234
- + A complete set allowing easy and safe installation
- + With foamed-in connection sleeve of choice
- + Fire protection plug for safe lead-through of cables and media

Sita Fireguard® pipe fairlead	DN	OD*	Insulation thickness (mm)	Article number
	100	110	60-180	F30 51 xx
	150	160	60-180	F30 52 xx

Installation example

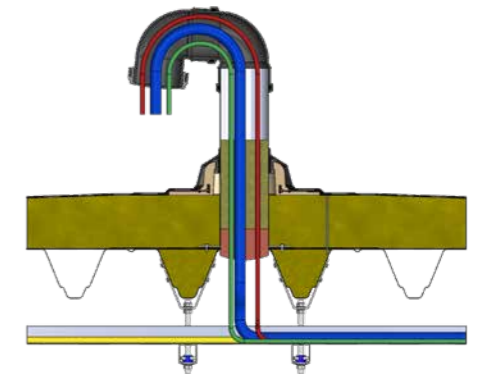

SitaMulti

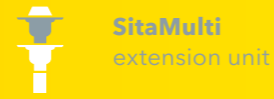

SitaDSS Multi



Properties

The SitaMulti roof outlet set new standards in versatility. Its fire resistance ensures it can be utilised in places with high fire protection requirements. Together with the SitaMulti grating frame, it is even possible to drive vehicles over it in a concreted structure.

- + Non-flammable
- + Loose/fixed flange construction
- + High discharge rate
- + Sizes up to DN 150

Installation example

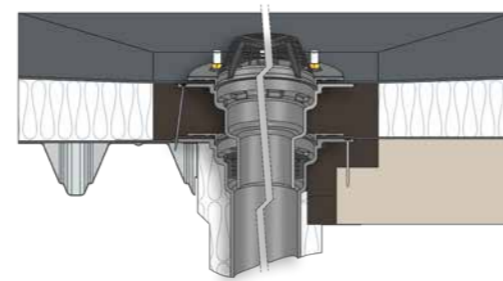

Properties

The SitaDSS Multi roof outlet set new standards in versatility. It was designed among other things, for the installation of internal gutters. Its fire resistance ensures it can be utilised in places with high fire protection requirements.

- + Non-flammable
- + Loose/fixed flange construction
- + Matching insulating body made of foam glass available
- + Suitable for gutters

Installation example

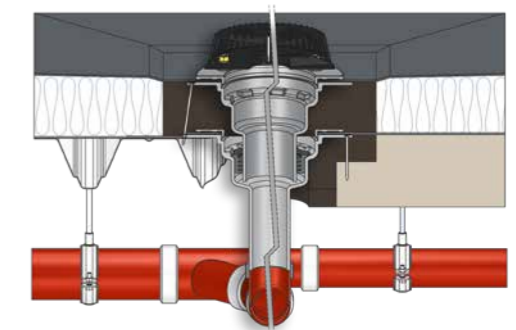

SitaMulti	DN	OD*	Article number
	80	83	40 03 99
	100	110	40 04 99
	125	135	40 06 99
	150	160	40 08 99

SitaMulti	Height (mm)	Article number
	80-300	40 27 99

Accessories



Quality marks



SitaDSS Multi	DN	OD*	Article number
	80	83	42 03 99
	80	83	42 33 99**

SitaDSS Multi	Insulation thickness (mm)	Article number
	80-300	42 27 99

Accessories

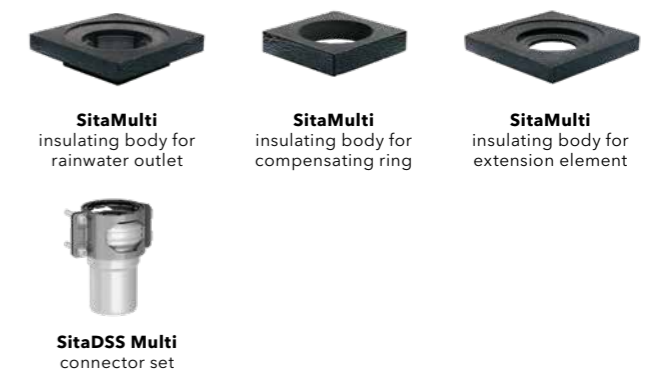

Quality marks



This is how easy combinations are generated.

Sitaleicht.
Fire
Protection.



Accessories	Product series					
	Sita Multi	SitaDSS Multi	SitaFireguard*	SitaDSS Fireguard*	SitaVent Fireguard*	SitaFireguard* pipe lead-through
SitaMore transition connector set 						
SitaFireguard* insulating body 						
SitaFireguard* pipe lead-through insulating body 						

FP

P

for SitaPipe:

Pipeline system for gravity drainage and siphonic drainage!

SitaPipe is the ideal complement for SitaGullys. With all shaped parts and securing materials in the SitaPipe series, pipeline systems for gravity drainage and siphonic drainage can be realised without gaps. Also the perfect solution for connecting to PUR gullies and stainless steel gullies.

SitaPipe stainless steel pipe system



SitaPipe stainless steel pipe system

Properties

A high-performance pipe system for siphonic and gravity drainage in stainless steel. The versatile modular system brings individual construction solutions and a timeless look to main and emergency drainage. It can be used wherever special requirements need to be met. The weather- and age-resistant stainless steel pipes are also suitable for outdoor use. Resistant to chemical stress and non-flammable, they meet high safety requirements.

- + For direct connection to Sita outlets
- + For main and emergency drainage
- + Low weight
- + For conventional and siphonic drainage

Components



SitaPipe stainless steel pipe



SitaPipe stainless steel bend



SitaPipe stainless steel cleaning pipe



SitaPipe stainless steel pipe clamp



SitaPipe stainless steel steel safety clamp



SitaPipe stainless steel steel branch 45°



SitaPipe stainless steel steel branch 87.5°



SitaPipe stainless steel adapter eccentric



SitaPipe stainless steel adapter centred



SitaPipe stainless steel reduction



SitaPipe flat roof branch



SitaPipe adapter



SitaPipe stainless steel expansion sleeve



SitaPipe stainless steel double plug-in coupler



SitaPipe stainless steel sealing plug











SitaPipe Edelstahl slide-on coupler

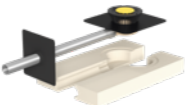

SitaPipe stainless steel mounting bracket

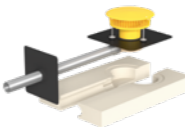
This is how easy combinations are generated.

Areas of application	Sample products*
 Conventional drainage	 SitaStandard
 Siphonic drainage	 SitaDSS Profi
 Parapet drainage	 Sitalndra
 Emergency drainage	 Sitalndra emergency drainage
 Balcony and terrace drainage	 SitaCompact

* Additional Sita gullies can be used.

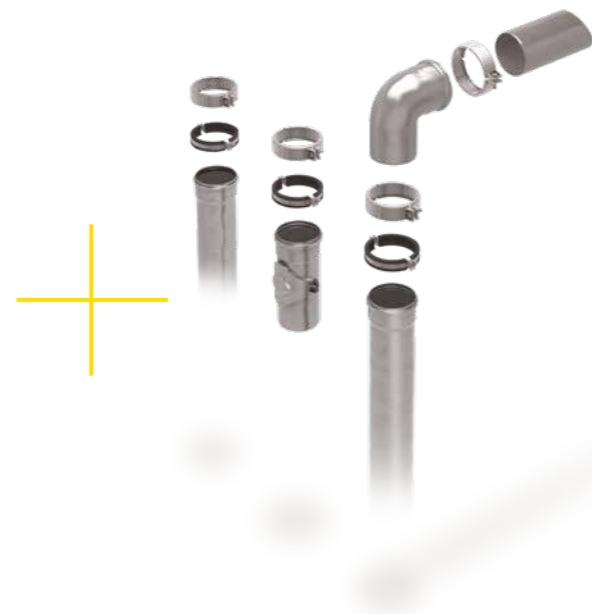

SitaPipe PP pipe system



SitaPipe PP pipe system

Properties





It's really easy to find the right downpipe for the conventional drainage outlet. The SitaPipe PP program means you don't have to spent time searching, and instantly brings system competence to the site. With millimetre accuracy, the individual system components are matched to each other and to the particular conventional drainage outlet. They can be connected directly to the roof outlet. A plug-in coupler system holds everything in place securely. And the ability to withstand pressures up to 1.5 bar provides peace of mind in case the ground pipeline is ever blocked or overloaded. In practice this means: Problem-free installation in buildings up to 15 metres in height.

- + For main and emergency drainage
- + UV stability - suitable for internal and external use
- + 3-layer composite system - dimensional stability and more impact-resistant
- + Sleeve connections, pipes and formed parts suitable for overpressures up to 1.5 bar - equivalent to a water column of 15 m
- + The economical connecting pipe system made of polypropylene - easy installation

Components

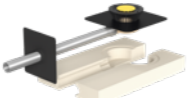

This is how easy combinations are generated.

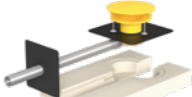
Areas of application	Sample products*
 <p>Conventional drainage</p>	 <p>SitaStandard</p>
 <p>Parapet drainage</p>	 <p>Sitalndra</p>
 <p>Emergency drainage</p>	 <p>Sitalndra emergency drainage</p>

* Additional Sita gullies can be used.



Sitaleicht.
SitaPipe.



Sitaleicht. Check it out online: sita-baelemente.de/gb/

Connection sleeves for outlets with article end numbers.

For SitaStandard, SitaTrendy, SitaDSS Profi, SitaIndra, SitaDSS Indra, SitaVasant**5, SitaEasy, SitaEasy Plus, SitaCompact, SitaCompact Near*4, SitaCarport, SitaMini*3, SitaSani®, SitaFireguard®, SitaDSS Fireguard®, SitaVent Fireguard® and SitaVent.

Sleeves from the series production

Product-/Trade name	Art. No. end number	Type	Manufacturer
Bitumen	00*1	Elastomerbitumen	
PVC soft	10	PVC - light grey	
Fluid	90	for liquid plastic seal (Order-related production lead-time approx: 5 working days ex works)	

Sleeves from the series production

Order-related production lead-time approx: 5 working days ex works

Surcharge see current price list

Product-/Trade name	Art. No. end number	Type	Manufacturer
Alkorplan F35276	49	PVC - medium grey	Renolit AG
Alkortec®	05	EVA - dark grey	
Alkortop® F	41	TPO - sand	
Armourplan G	45	PVC - medium grey	IKO Polymeric
Elevate UltraPly	42	TPO/FPO - grey	Holcim Solutions and Products EMEA BV
Elevate UltraPly	54	TPO/FPO - white	
Evalastic V	22*1	EPDM - light grey	Alwitra GmbH
Evalon V	25*1	EVA - white	
Evalon V	37*1	EVA - light grey	
Evalon V	50*1	EVA - slate grey	
EverGuard	77	FPO - light grey	
Extrupol F	32*1	FPO - light grey	Schedetal Folien GmbH
Flagon EP-S	31	FPO - sand grey	SOPREMA GmbH
Flagon EP	73	FPO - basalt grey	
Flagon SR	66	PVC - light grey	
Hertalan Easy Weld	07	EPDM - black	Carlisle Construction Materials GmbH
Köster ECB 2.0 F	72*1	ECB - black	Köster Bauchemie AG
Köster TPO 2.0 F	48*1	TPE - light grey	
Mapeplan D 15	06	PVC - light grey	Mapei GmbH (DE)
Mapeplan-T	04	FPO - smartwhite	Polyfin AG
Polyfin 4020 v	16*1	FPO - light grey	
Protan D	80	PVC soft - dark grey	Protan Deutschland GmbH
Resitrix CL	01*2	EPDM - black	Carlisle Construction Materials GmbH
Rhepanol HG 18	34	PIB - grey	FDT Flachdachtechnologie GmbH & Co. KG
Sarnafil®-TG 66-15	24	FPO - beige	Sika GmbH
Sarnafil®-TG 66-15	76	FPO - grau	
Sikaplan® 15G	09	PVC - light grey	
Sintofol RG FR	0104	TPO - light grey	GEORG BÖRNER GmbH & Co. KG
Sintofol ST	57	TPO - light grey	
Spectraplan SG	46	TPE - grey	IKO Polymeric
Tectofin RV plus	0105*1	ASA-PVC-P - grey	BMI Wolfin Bautechnik
Thermofin F15	02	FPO - silver grey	Paul Bauder GmbH & Co. KG
Thermofol U15	52	PVC - anthrazit	
Thermoplan TL 15	29	FPO - pearl white	
Thermoplan TL 18	0106	FPO - granite black	
Thermoplan TL 18	0107	FPO - silver grey	
VAEPLAN F	35	EVA - grey	VAEPLAN GmbH
Wolfin IB	20	PVC-PBV - black	BMI Wolfin Bautechnik

Surcharge see current price list

NovoProof joining technology	84	EPDM - black	CQLT SaarGummi Deutschland GmbH
Thermobond R	75	EPDM - black	Sealeco GmbH

Surcharge see current price list

Elevate Quickseam SA Flashing	03	EPDM - black	Holcim Solutions and Products EMEA BV
-------------------------------	----	--------------	---------------------------------------

Surcharge see current price list

Hertalan with joining technology	82	EPDM - black	Carlisle Construction Materials GmbH
----------------------------------	----	--------------	--------------------------------------

*1 Fleece-backed membrane. *2 Bitumen side on top. *3 except 03 und 84. *4 except 00 und 90. *5 except 90.

Further connection sleeves upon request.

Connection sleeves for outlets with article end numbers.

For SitaTurbo and SitaTurbo Max.

Sleeves from the series production

Order-related production lead-time approx: 5 working days ex works

Surcharge see current price list

Product-/Trade name	Art. No. end number	Type	Manufacturer
Bitumen underlay	70	Elastomerbitumen	
Bitumen top layer	71	Polymerbitumen	
Alkorplan F35276	49	PVC - medium grey	Renolit AG
Alkortec®	05	EVA - dark grey	
Alkortop® F	41	TPO - sand	
Armourplan G	45	PVC - medium grey	IKO Polymeric
Elevate UltraPly	42	TPO/FPO - grey	Holcim Solutions and Products EMEA BV
Elevate UltraPly	54	TPO/FPO - white	
Evalastic	87	EPDM - light grey	Alwitra GmbH
Evalon	88	EVA - white	
Evalon	85	EVA - light grey	
Evalon	0102	EVA - slate grey	
EverGuard	77	FPO - light grey	
Extrupol M 1.8	0100	FPO - light grey	Schedetal Folien GmbH
Flagon EP-S	31	FPO - sand grey	SOPREMA GmbH
Flagon EP	73	FPO - basalt grey	
Flagon SR	66	PVC - light grey	
Hertalan Easy Weld	07	EPDM - black	Carlisle Construction Materials GmbH
Köster ECB 2.0	0103	ECB - black	Köster Bauchemie AG
Köster TPO 2.0	0101	TPE - light grey	
Mapeplan D 15	06	PVC - light grey	Mapei GmbH (DE)
Mapeplan-T	04	FPO - light grey	
O.C. Plan 3020	89	ECB - black	Polyfin AG
Polyfin 3020	86	FPO - light grey	
PVC soft	10	PVC - light grey	Paul Bauder GmbH & Co. KG
Protan D	80	PVC soft - dark grey	Protan Deutschland GmbH
Resitrix CL	01	EPDM - black	Carlisle Construction Materials GmbH
Rhepanol HG 18	34	PIB - grey	Sika GmbH
Sarnafil®-TG 66-15	24	FPO - beige	
Sarnafil®-TG 66-15	76	FPO - grey	
Sikaplan® 15G	09	PVC - light grey	GEORG BÖRNER GmbH & Co. KG
Sintofol RG FR	0104	TPO - light grey	
Sintofol ST	57	TPO - light grey	IKO Polymeric
Spectraplan SG	46	TPE - grey	
Tectofin RG	18	ASA-PVC-P - grey	BMI Wolfin Bautechnik
Thermofin F15	02	FPO - silver grey	Paul Bauder GmbH & Co. KG
Thermofol U15	52	PVC - anthrazit	
Thermoplan TL 15	29	FPO - pearl white	
Thermoplan TL 18	0106	FPO - granite black	
Thermoplan TL 18	0107	FPO - silver grey	
VAEPLAN F	35	EVA - grey	VAEPLAN GmbH

Sita:

1 Award-winning.

Sita - meets the standards

Standard ISO 9001 defines the requirements for a company's certifiable quality management system. The required properties of the products and services are regularly monitored by a certified company to satisfy quality-related customer requirements.



Standard ISO 14001 defines the requirements for a company's certifiable environmental management system. The fulfilment of environmental objectives and their continuous improvement are monitored and evaluated.

Sita - among the 100 most innovative companies

The TOP 100 has been recognising the most innovative medium-sized German companies for the last 25 years. Sita was added to the list in 2017 - including for its excellent knowledge of technical requirements and its permanent exchange with dealers, roofers and architects.



3 Supports standards.

Sita is a member of the IFBS

The Industrial Federation for Construction Systems in Lightweight Steel assures the quality standards of large components and drafts technical rules and regulations.



Compliance with regulations: Sita and DIN

As a DIN member, Sita can network efficiently with other experts. That enables Sita to support the well-proven system of standardisation and at the same time to give its input - for future standards strategies.



Sita and the RAL quality mark

A guarantee of top quality and safety: RAL quality mark & services goes beyond the statutory requirements. It is a legally binding decision-making aid for architects, craftsmen and developers.



Other Sita quality documents:



2 Product-tested.

Tested safety by TÜV

Certification by TÜV Rheinland LGA Products GmbH is a procedure which Sita Bauelemente GmbH undertakes on a voluntary basis. It provides you with the guarantee that Sita products comply with the requirements of DIN EN 1253 and are regularly monitored by an independent institution.



Regulated by the Ü mark

Roof outlets are manufactured in accordance with DIN EN 1253-2 and treated as regulated building products under Building Regulations List A Part 1. Its applicability must be confirmed in the compliance verification required for this purpose - why Sita bears the compliance mark (Ü mark).



New 6-year assurance: ZVDH material guarantee

Sita has lodged a comprehensive guarantee for almost all its products via the ZVDH. This provides registered companies not only with compensation in the event of damage but also the assurance of the reimbursement of the removal, installation and, if necessary, scaffolding set-up costs.



4 Protects the environment

Interseroh Climate Protection Certificate

Sita is one of the companies protecting the climate by its good example: Recycling transport packaging helps to prevent millions of tonnes of greenhouse gases and recover valuable resources.



Sita uses green electricity

The electricity Sita purchases comes from systems which generate electricity from renewable sources.



Our free calculation service.

**Do you need planning security?
We can provide advice and help.
And we make it very easy for you.**

Our experts calculate your main and emergency drainage in compliance with the standards, based on the data of your roof area. Giving us the location of your project enables us to include precise rainfall data in the calculation. That gives you an accurate result calculated easily and exclusive for exactly your project-personal and precise. Simply complete our online form and send it to us.

If you have any questions,
feel free to give us a call:
+44 (0) 7402239777



**Sita advice provided
the security
I needed at all
phases of planning
and construction.**

Sitaleicht.
When
responsibility
doesn't feel
heavy.



Sita direct. Contacts.

Export
Manager



Export Manager
Udo Happe
Ferdinand-Braun-Straße 1
D-33378 Rheda-Wiedenbrück
T +49 2522 8340-178
M +49 173 6588061
E u.happe@sita-bauelemente.de

Technical
Consultant



Technical Consultant
Ben Ward
Sita Bauelemente GmbH/UK
26 Whirlow Court Road
Sheffield, S11 9NT
United Kingdom
T +44 (0) 7402239777
E b.ward@sita-bauelemente.co.uk

Sales
Department
Export



Sarah Möller
Ferdinand-Braun-Straße 1
D-33378 Rheda-Wiedenbrück
T +49 2522 8340-149
E s.moeller@sita-bauelemente.de

Internal Sales Conventional Drainage
F +49 2522 8340-140
E vertrieb@sita-bauelemente.de



**Sita360°
Tour.**

Discover Sita easily and simply in our 360 tour.



Sita product segments:



Conventional
drainage



Balcony and
terrace drainage



Fire
protection



Siphonic
drainage



Drainage



Pipe



Emergency
drainage



Green roof and
retention



Parapet
drainage



Refurbishment



Kaskade



Ventilation and
pipe fairlead

Sita Bauelemente GmbH
Ferdinand-Braun-Straße 1
33378 Rheda-Wiedenbrück
T +49 2522 8340-0
E info@sita-bauelemente.de
W sita-bauelemente.de

